

## Suave planter ø42x65 cm

by Marcel Wanders

Suave in&out furniture collection, designed by Marcel Wanders for Vondom, blends the boundaries between indoor and outdoor furniture and achieves a higher level of softness, comfort and relaxation.



## Info

---

### Description

Pot made of polyethylene resin by rotational moulding. 100% Recyclable. Item suitable for indoor and outdoor use. Available in different finishes.

Weight: 6.42 Kg

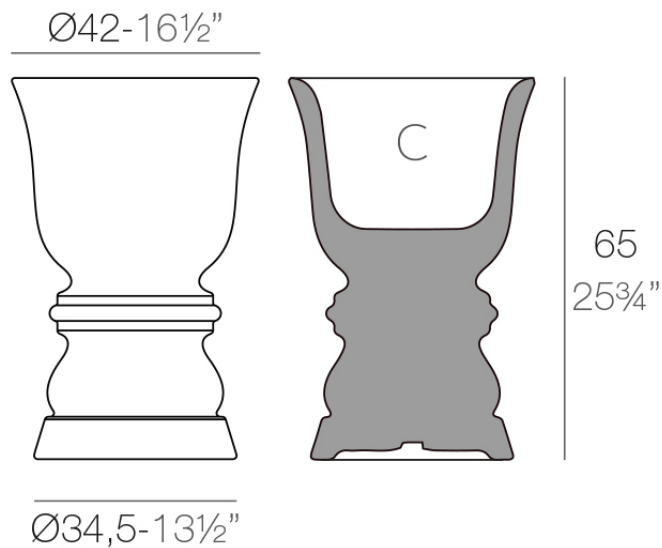

SUAVE Macetero 65 cm  
SUAVE Planter 25 3/4"

C = 43 L  
C = 11 1/4 gal

## Finishes

---

### finishes

---

#### BASIC

Ref. 67011A



crema



green



purjai red



orange

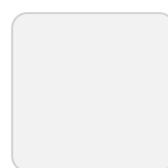

ice



notte blue



white



black



bronze



steel



anthracite



red



khaki



taupe



ecru



beige

#### Matt Polyethylene

#### SELF-WATERING

Ref. 67011R

# VONDOM

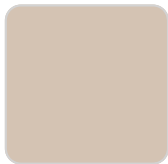

crema

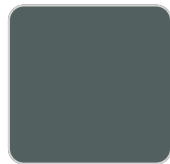

green

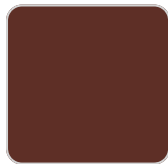

purjai red

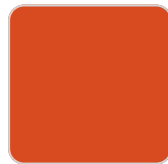

orange

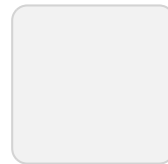

ice



notte blue



white



black

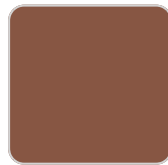

bronze

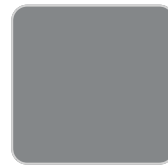

steel

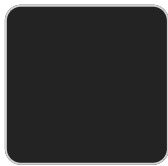

anthracite

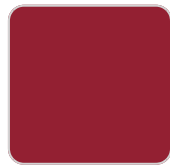

red

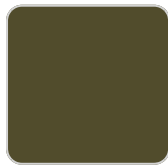

khaki

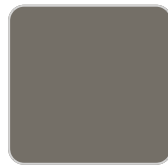

taupe

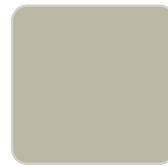

ecru



beige

Self-watering system included in all planters except those with basic finish

## LACQUERED

Ref. 67011RF



purjai red



white



black



bronze



steel



anthracite



red



khaki



taupe



ecru



beige



modo green



champany

Lacquered Polyethylene

## lighting

---

WHITE LED

Ref. 67011W

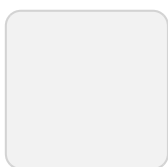

ice

White internally lit unit with LED technology. Available only in matte ice white finish.

RGBW LED

Ref. 67011L



ice

Unit with internal lighting with RGBW LED technology and remote control unit for switching colors. Available only in matte ice white finish. Remote control included.

RGBW LED DMX

Ref. 67011D



ice

Unit with internal lighting with RGBW LED technology and remote control unit for switching colors. Also controlled by DMX-1024 (wireless), enabling communication between one or more products simultaneously via the DMX transmitter (not included). There are two options to choose from: Professional XLR DMX and Home WIFI DMX. (Remote control included). Optional battery

## RGBW LED BATTERY

Ref. 67011Y



ice

Unit with internal lighting with battery-powered RGBW LED technology. Includes charger and remote control for switching colors and charger. Available only in matte ice white finish.

## RGBW LED DMX BATTERY

Ref. 67011DY

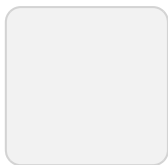

ice

Unit with internal lighting with RGBW LED technology and remote control unit for switching colors. Also controlled by DMX-1024 (wireless), enabling communication between one or more products simultaneously via the DMX transmitter (not included). There are two options to choose from: Professional XLR

# VONDOM

DMX and Home WIFI DMX. (Remote control included).

## Ambients

---





## Suave planter ø55x100 cm

by Marcel Wanders

Suave in&out furniture collection, designed by Marcel Wanders for Vondom, blends the boundaries between indoor and outdoor furniture and achieves a higher level of softness, comfort and relaxation.



## Info

---

### Description

Pot made of polyethylene resin by rotational moulding. 100% Recyclable. Item suitable for indoor and outdoor use. Available in different finishes.

Weight: 10.7 Kg

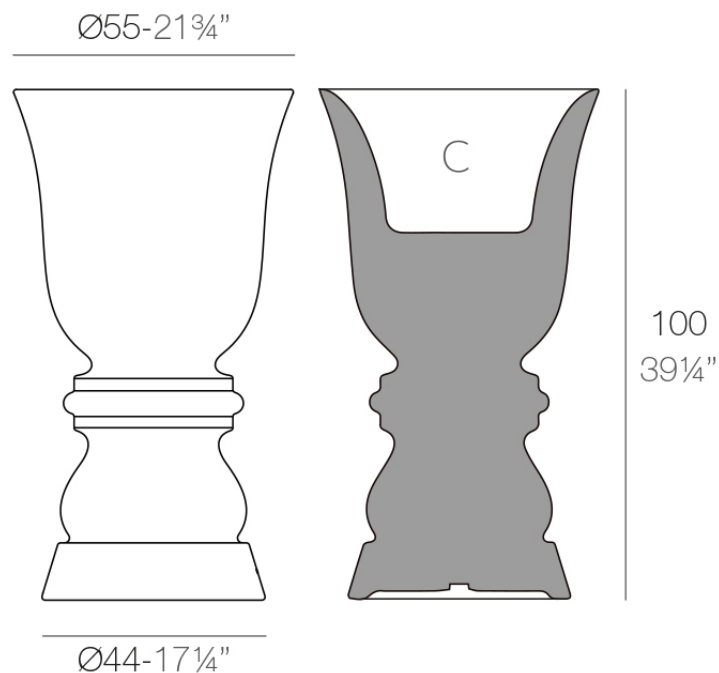

SUAVE Macetero 100 cm  
SUAVE Planter 39 1/4"

C = 82 L  
C = 21 3/4 gal

## Finishes

---

### finishes

---

#### BASIC

Ref. 67012A



orange

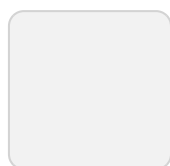

ice



notte blue



crema



green



purjai red



white



black



bronze



steel



anthracite



red



khaki



taupe



ecru



beige

#### Matt Polyethylene

#### SELF-WATERING

Ref. 67012R

# VONDOM



orange



ice



notte blue



crema

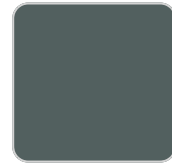

green



purjai red



white



black

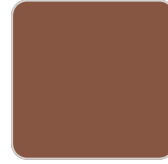

bronze



steel



anthracite

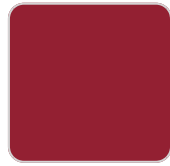

red



khaki



taupe

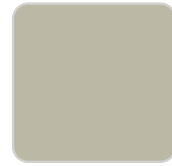

ecru



beige

Self-watering system included in all planters except those with basic finish

## LACQUERED

Ref. 67012RF



purjai red



white



black



bronze



steel



anthracite



red



khaki



taupe



ecru

# VONDONM



beige



modo green



champany

Lacquered Polyethylene

## lighting

---

WHITE LED

Ref. 67012W

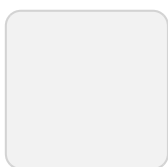

ice

White internally lit unit with LED technology. Available only in matte ice white finish.

RGBW LED

Ref. 67012L



ice

Unit with internal lighting with RGBW LED technology and remote control unit for switching colors. Available only in matte ice white finish. Remote control included.

RGBW LED BATTERY

Ref. 67012Y



ice

Unit with internal lighting with battery-powered RGBW LED technology. Includes charger and remote control for switching colors and charger. Available only in matte ice white finish.

## RGBW LED DMX BATTERY

Ref. 67012DY



ice

Unit with internal lighting with RGBW LED technology and remote control unit for switching colors. Also controlled by DMX-1024 (wireless), enabling communication between one or more products simultaneously via the DMX transmitter (not included). There are two options to choose from: Professional XLR DMX and Home WIFI DMX. (Remote control included).

## Ambients

---



## Suave planter ø75x150 cm

by Marcel Wanders

Suave in&out furniture collection, designed by Marcel Wanders for Vondom, blends the boundaries between indoor and outdoor furniture and achieves a higher level of softness, comfort and relaxation.





## Info

---

### Description

Pot made of polyethylene resin by rotational moulding. 100% Recyclable. Item suitable for indoor and outdoor use. Available in different finishes.

Weight: 11.29 Kg

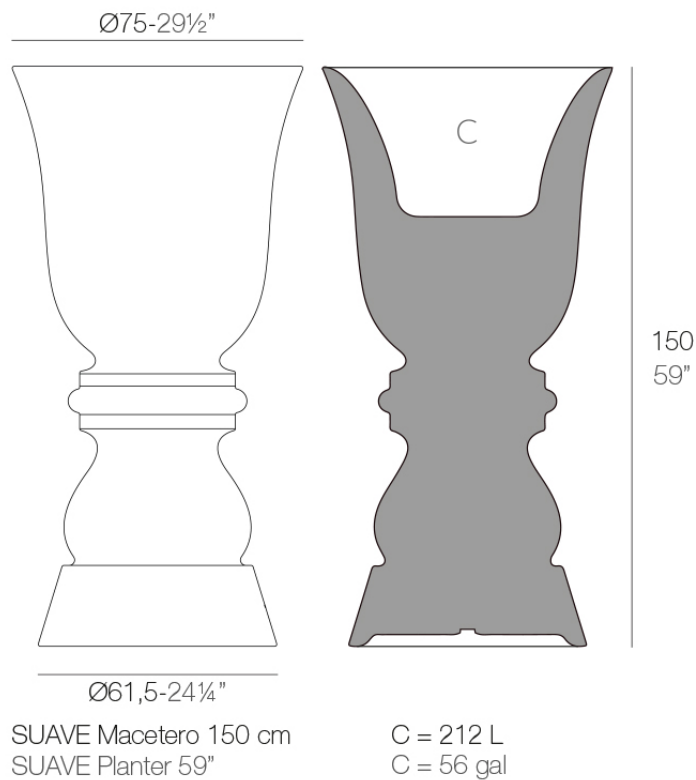

## Finishes

---

### finishes

---

#### BASIC

Ref. 67013A



crema



green



orange



notte blue

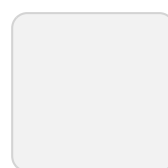

ice



purjai red



white



black



bronze



steel



anthracite



red



khaki

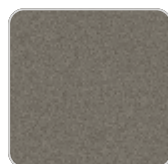

taupe

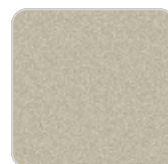

ecru



beige

#### Matt Polyethylene

#### SELF-WATERING

Ref. 67013R

# VONDOM

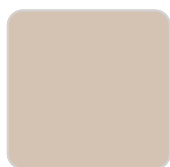

crema

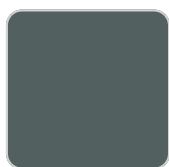

green



orange



notte blue

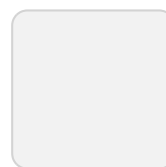

ice

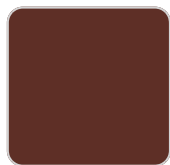

purjai red



white



black

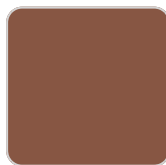

bronze



steel



anthracite



red



khaki



taupe



ecru



beige

Self-watering system included in all planters except those with basic finish

## LACQUERED

Ref. 67013RF



purjai red



white



black



bronze



steel



anthracite



red



khaki



taupe



ecru

# VONDOM



beige



modo green



champany

Lacquered Polyethylene

## lighting

---

WHITE LED

Ref. 67013W



ice

White internally lit unit with LED technology. Available only in matte ice white finish.

RGBW LED

Ref. 67013L

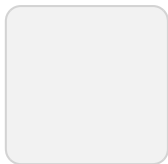

ice

Unit with internal lighting with RGBW LED technology and remote control unit for switching colors. Available only in matte ice white finish. Remote control included.

RGBW LED DMX

Ref. 67012D



ice

Unit with internal lighting with RGBW LED technology and remote control unit for switching colors. Also controlled by DMX-1024 (wireless), enabling communication between one or more products simultaneously via the DMX transmitter (not included). There are two options to choose from: Professional XLR DMX and Home WIFI DMX. (Remote control included). Optional battery

## RGBW LED BATTERY

Ref. 67013Y



ice

Unit with internal lighting with battery-powered RGBW LED technology. Includes charger and remote control for switching colors and charger. Available only in matte ice white finish.

## RGBW LED DMX BATTERY

Ref. 67013DY

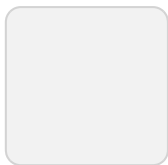

ice

Unit with internal lighting with RGBW LED technology and remote control unit for switching colors. Also controlled by DMX-1024 (wireless), enabling communication between one or more products simultaneously via the DMX transmitter (not included). There are two options to choose from: Professional XLR

# VONDOM

DMX and Home WIFI DMX. (Remote control included).

## Ambients

---

