

Quartz chair

by Ramón Esteve

The Quartz chairs and table collection, designed by Ramón Esteve for Vondom, is characterized by its **orthogonal geometry and triangular shaped profiles**. Due to the line of one of its vertexes this piece appears extremely light.



Info

Description

Injected polypropylene with fiber glass. Stackable. Item suitable for indoor and outdoor use.

Weight: 3 Kg

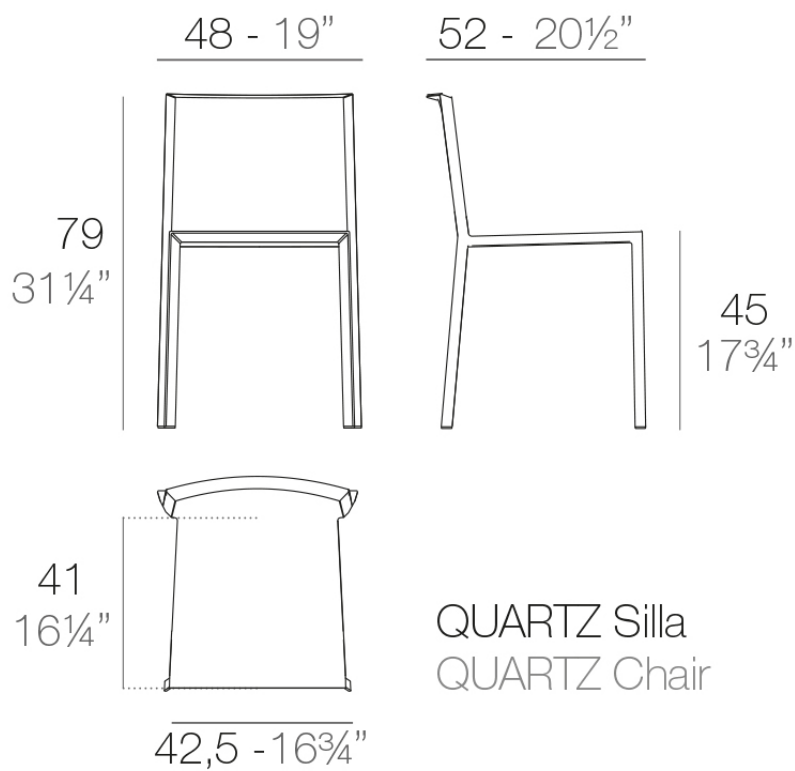

Accessories

- Fabric

Finishes

finishes

BASIC PP
Ref. 54194



white



black



bronze

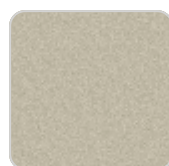

ecru



tortora

Available in various colors

LACQUERED COLOR INJECTION PP
Ref. 54194F



anthracite 3106



black 3102

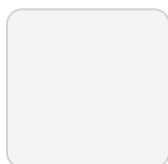

white 3101



red 3114

-

Ambients

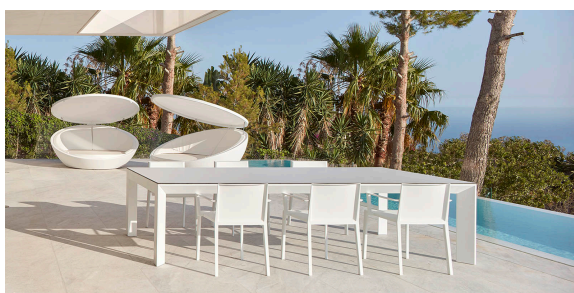
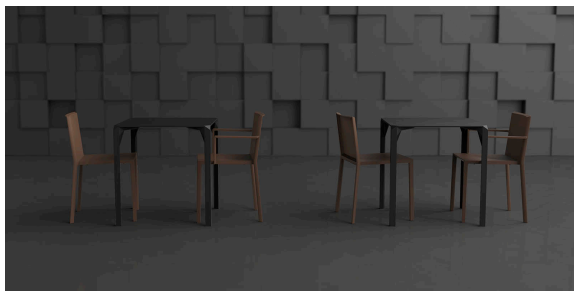

Quartz chair with arms

by Ramón Esteve

The Quartz chairs and table collection, designed by Ramón Esteve for Vondom, is characterized by its **orthogonal geometry and triangular shaped profiles**. Due to the line of one of its vertexes this piece appears extremely light.



Info

Description

Injected polypropylene with fiber glass. Stackable. Item suitable for indoor and outdoor use.

Weight: 3 Kg

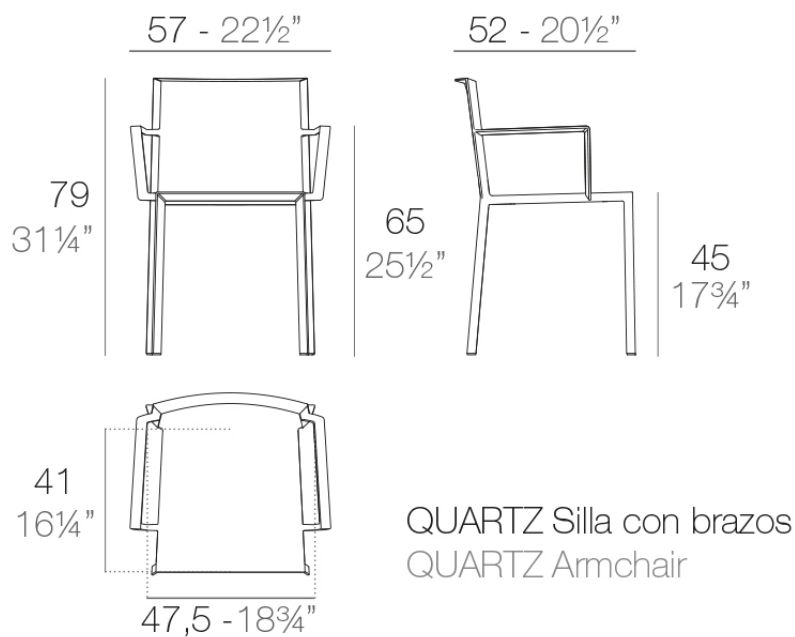

Accessories

- Fabric

Finishes

finishes

BASIC PP
Ref. 54195



white



black



bronze

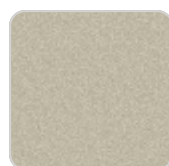

ecru



tortora

Available in various colors

LACQUERED COLOR INJECTION PP
Ref. 54195F



black 3102

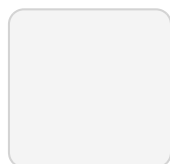

white 3101



red 3114



anthracite 3106

-

Ambients

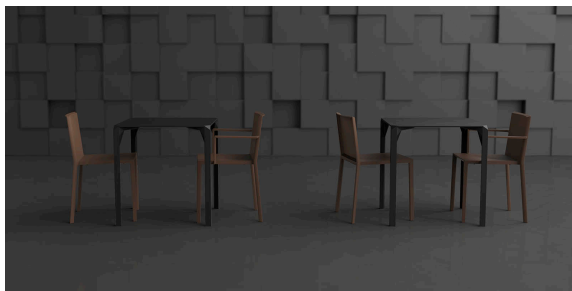

Quartz folding chair

by Ramón Esteve

The Quartz chairs and table collection, designed by Ramón Esteve for Vondom, is characterized by its **orthogonal geometry and triangular shaped profiles**. Due to the line of one of its vertexes this piece appears extremely light.



Info

Description

Injected polypropylene with fiber glass. Stackable. Item suitable for indoor and outdoor use.

Weight: 4.81 Kg

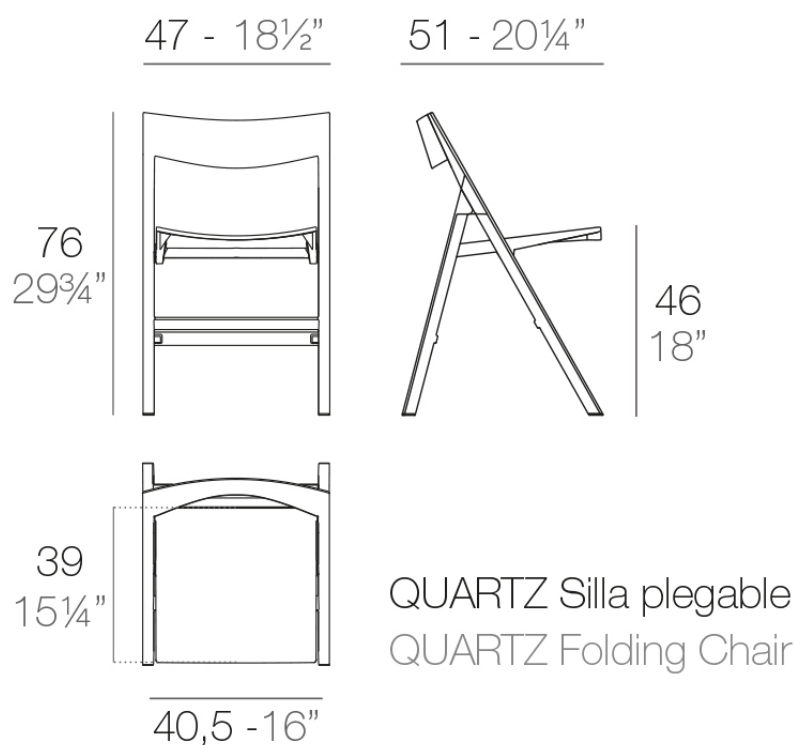

Finishes

finishes

BASIC PP
Ref. 54197



white



black



ecru

Available in various colors

Ambients

