

Products / Low Tables / Gatsby Base ø40x25 S50

Gatsby base ø40x25 s50

by Ramón Esteve

The Gatsby collection, designed by Ramón Esteve for Vondom, recalls the Art Déco lighting. Those crazy twenties. “Something new, extraordinary, beautiful, simple but sophisticatedly designed” said Francis Scott Fitzgerald about his aims for the novel he was about to write. The Great Gatsby was born in an age of prosperity, parties and excess. They called it “the American Dream”.

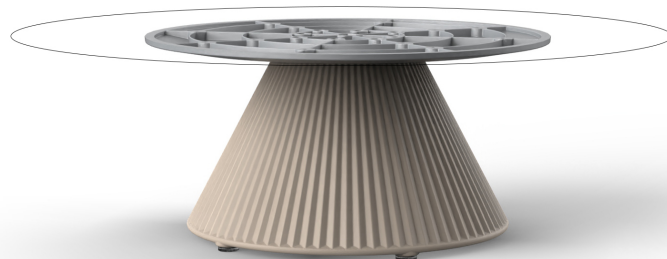

Info

Description

Weight: 2.44 Kg

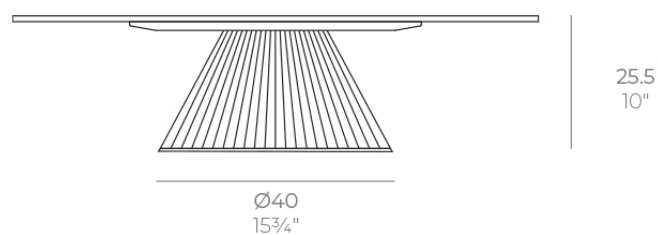

GATSBY Mesa Base Redonda Ø40x25.5cm S50
GATSBY Round Base Table Ø40x25.5cm S50
ref. 54441

TABLE TOP - SOBRE

- Ø79 cm
Ø31"
- Ø89 cm
Ø35"
- Ø100 cm
Ø39¼"

Accessories

- TABLE 10mm
- TABLE 12mm
- TABLE DEKTON

Finishes

finishes

BASIC

Ref. 54441



orange

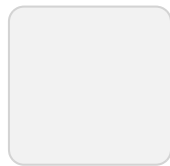

ice



notte blue



crema

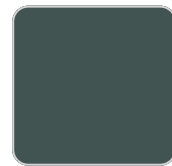

green

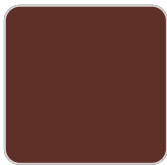

purjai red



white



black



bronze



steel



anthracite



red



khaki



taupe



ecru



beige

Matt Polyethylene

Products / Low Tables / Gatsby Base 35x35x25 S30

Gatsby base 35x35x25 s30

by Ramón Esteve

The Gatsby collection, designed by Ramón Esteve for Vondom, recalls the Art Déco lighting. Those crazy twenties. “Something new, extraordinary, beautiful, simple but sophisticatedly designed” said Francis Scott Fitzgerald about his aims for the novel he was about to write. The Great Gatsby was born in an age of prosperity, parties and excess. They called it “the American Dream”.

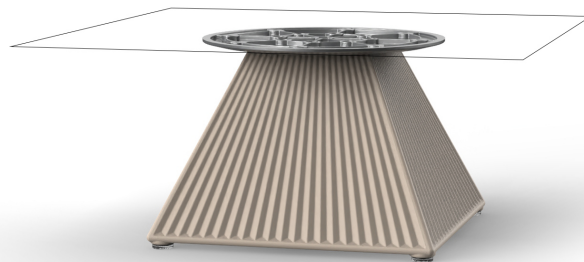

Info

Description

Weight: 3.15 Kg

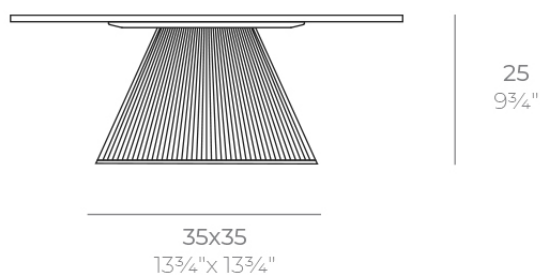

GATSBY Mesa Base Cuadrada 35x35x25cm S30
GATSBY Square Base Table 35x35x25cm S30
ref. 54442

TABLE TOP - SOBRE

■ 50 x 50 cm
19¹/₄" x 19¹/₄"

■ 59 x 59 cm
23¹/₄" x 23¹/₄"

Accessories

- TABLE 10mm
- TABLE 12mm
- TABLE DEKTON

Finishes

finishes

BASIC

Ref. 54442



orange



ice

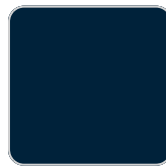

notte blue



crema

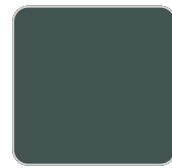

green

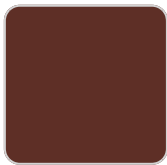

purjai red



white



black



bronze



steel



anthracite



red



khaki



taupe



ecru



beige

Matt Polyethylene

Products / Low Tables / Gatsby Base 35x35x25 S50

Gatsby base 35x35x25 s50

by Ramón Esteve

The Gatsby collection, designed by Ramón Esteve for Vondom, recalls the Art Déco lighting. Those crazy twenties. “Something new, extraordinary, beautiful, simple but sophisticatedly designed” said Francis Scott Fitzgerald about his aims for the novel he was about to write. The Great Gatsby was born in an age of prosperity, parties and excess. They called it “the American Dream”.

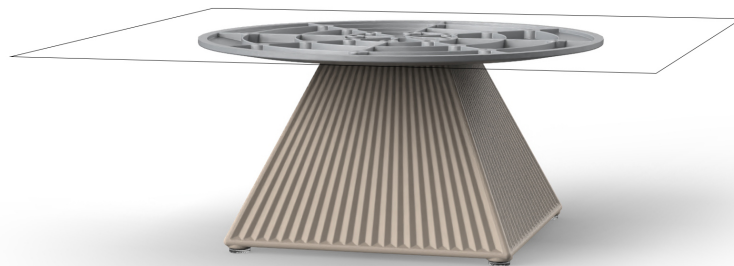

Info

Description

Weight: 3.21 Kg

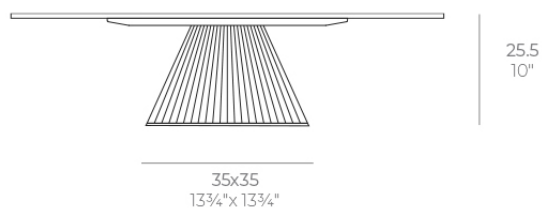

GATSBY Mesa Base Cuadrada 35x35x25cm S50
GATSBY Square Base Table 35x35x25cm S50
ref. 54443

TABLE TOP - SOBRE

- 69 x 69 cm
27 1/4" x 27 1/4"
- 79 x 79 cm
31" x 31"
- 89 x 89 cm
35" x 35"
- 100 x 100 cm
39 1/4" x 39 1/4"

Accessories

- TABLE 10mm
- TABLE 12mm
- TABLE DEKTON

Finishes

finishes

BASIC

Ref. 54443



crema

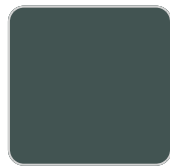

green

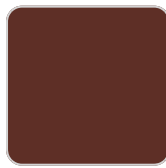

purjai red



orange



ice



notte blue



white



black



bronze



steel



anthracite



red



khaki



taupe



ecru



beige

Matt Polyethylene

Products / Low Tables / Gatsby Base ø40x40cm S30

Gatsby base ø40x40cm s30

by Ramón Esteve

The Gatsby collection, designed by Ramón Esteve for Vondom, recalls the Art Déco lighting. Those crazy twenties. “Something new, extraordinary, beautiful, simple but sophisticatedly designed” said Francis Scott Fitzgerald about his aims for the novel he was about to write. The Great Gatsby was born in an age of prosperity, parties and excess. They called it “the American Dream”.

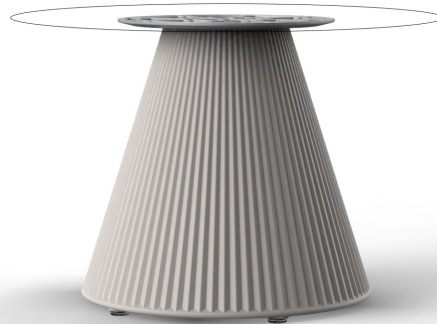

Info

Description

Weight: 3 Kg

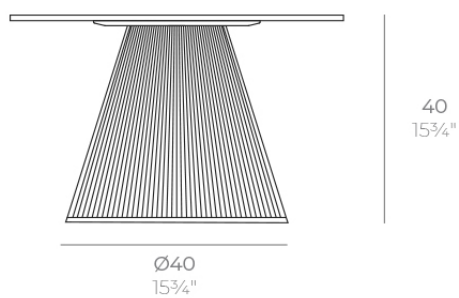

GATSBY Mesa Base Redonda Ø40x40cm S30
GATSBY Round Base Table Ø40x40cm S30
ref. 54444

TABLE TOP - SOBRE

- Ø50 cm
Ø19 1/4"
- Ø59 cm
Ø23 1/4"
- Ø69 cm
Ø27 1/4"

Accessories

- TABLE 10mm
- TABLE 12mm
- TABLE DEKTON

Finishes

finishes

BASIC

Ref. 54444



orange



ice

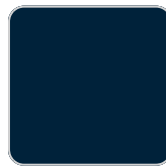

notte blue



crema

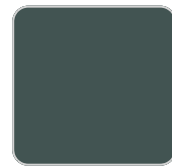

green

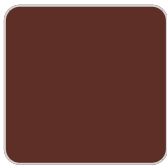

purjai red



white



black



bronze



steel



anthracite



red



khaki



taupe



ecru



beige

Matt Polyethylene

Products / Low Tables / Gatsby Base ø40x40cm S50

Gatsby base ø40x40cm s50

by Ramón Esteve

The Gatsby collection, designed by Ramón Esteve for Vondom, recalls the Art Déco lighting. Those crazy twenties. “Something new, extraordinary, beautiful, simple but sophisticatedly designed” said Francis Scott Fitzgerald about his aims for the novel he was about to write. The Great Gatsby was born in an age of prosperity, parties and excess. They called it “the American Dream”.



Info

Description

Weight: 3.24 Kg

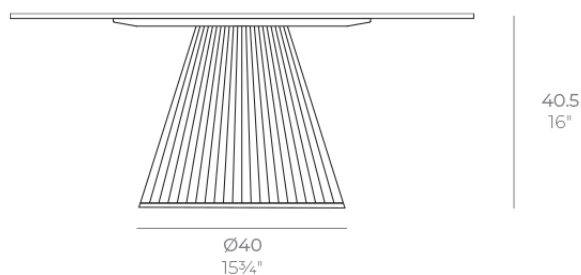

GATSBY Mesa Base Redonda Ø40x40.5cm S50
GATSBY Round Base Table Ø40x40.5cm S50
ref. 54445

TABLE TOP - SOBRE

- Ø79 cm
Ø31"
- Ø89 cm
Ø35"
- Ø100 cm
Ø39 1/4"

Accessories

- TABLE 10mm
- TABLE 12mm
- TABLE DEKTON

Finishes

finishes

BASIC

Ref. 54445



orange



notte blue

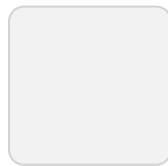

ice



crema

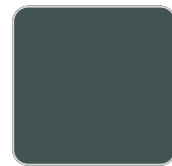

green

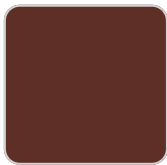

purjai red



white



black



bronze



steel



anthracite



red



khaki



taupe



ecru



beige

Matt Polyethylene

Products / Low Tables / Gatsby Base 35x35x40cm S30

Gatsby base 35x35x40cm s30

by Ramón Esteve

The Gatsby collection, designed by Ramón Esteve for Vondom, recalls the Art Déco lighting. Those crazy twenties. “Something new, extraordinary, beautiful, simple but sophisticatedly designed” said Francis Scott Fitzgerald about his aims for the novel he was about to write. The Great Gatsby was born in an age of prosperity, parties and excess. They called it “the American Dream”.

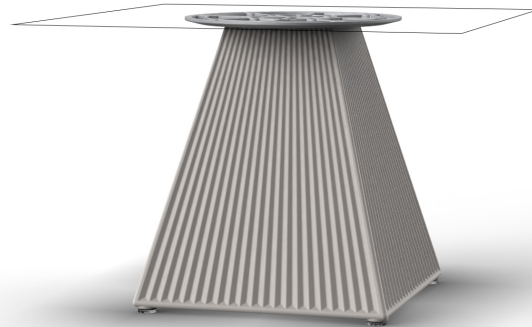

Info

Description

Weight: 4.3 Kg

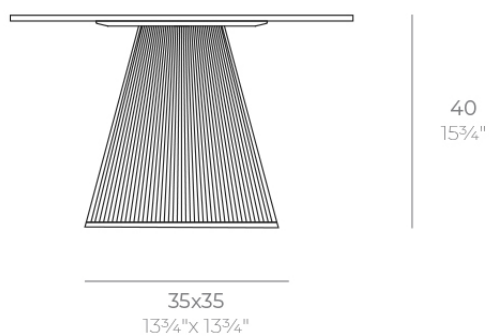

GATSBY Mesa Base Cuadrada 35x35x40cm S30
GATSBY Square Base Table 35x35x40cm S30
ref. 54446

TABLE TOP - SOBRE

- 50 x 50 cm
19¹/₄" x 19¹/₄"
- 59 x 59 cm
23¹/₄" x 23¹/₄"

Accessories

- TABLE 10mm
- TABLE 12mm
- TABLE DEKTON

Finishes

finishes

BASIC

Ref. 54446



orange



ice



notte blue



crema

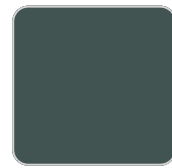

green

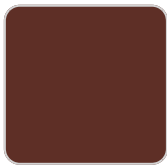

purjai red



white



black



bronze



steel



anthracite



red



khaki



taupe



ecru



beige

Matt Polyethylene

Products / Low Tables / Gatsby Base 35x35x40cm S50

Gatsby base 35x35x40cm s50

by Ramón Esteve

The Gatsby collection, designed by Ramón Esteve for Vondom, recalls the Art Déco lighting. Those crazy twenties. “Something new, extraordinary, beautiful, simple but sophisticatedly designed” said Francis Scott Fitzgerald about his aims for the novel he was about to write. The Great Gatsby was born in an age of prosperity, parties and excess. They called it “the American Dream”.

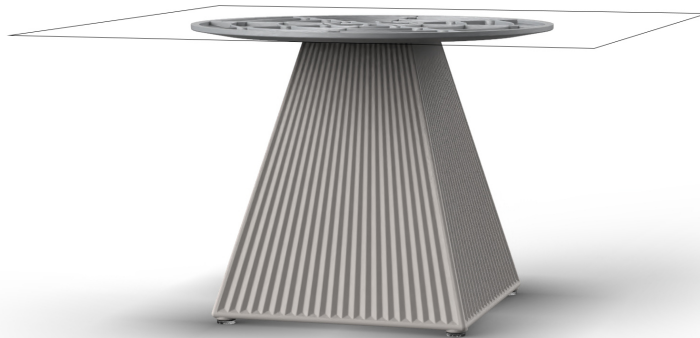

Info

Description

Weight: 4.3 Kg

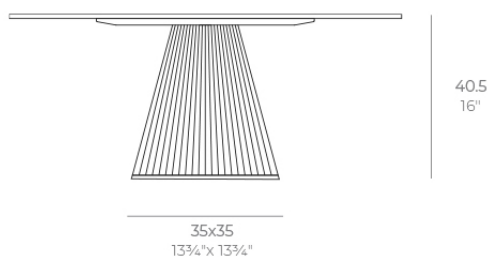

GATSBY Mesa Base Cuadrada 35x35x40.5cm S50
GATSBY Square Base Table 35x35x40.5cm S50
ref. 54447

TABLE TOP - SOBRE

- 69 x 69 cm
27¹/₄" x 27¹/₄"
- 79 x 79 cm
31" x 31"
- 89 x 89 cm
35" x 35"
- 100 x 100 cm
39¹/₄" x 39¹/₄"

Accessories

- TABLE 10mm
- TABLE 12mm
- TABLE DEKTON

Finishes

finishes

BASIC

Ref. 54447



orange



ice

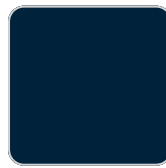

notte blue



crema

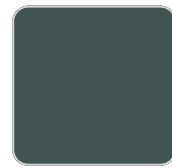

green

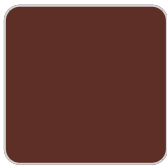

purjai red



white



black



bronze



steel



anthracite



red



khaki



taupe



ecru



beige

Matt Polyethylene

Products / Low Tables / Gatsby Base ø35x50cm S30

Gatsby base ø35x50cm s30

by Ramón Esteve

The Gatsby collection, designed by Ramón Esteve for Vondom, recalls the Art Déco lighting. Those crazy twenties. “Something new, extraordinary, beautiful, simple but sophisticatedly designed” said Francis Scott Fitzgerald about his aims for the novel he was about to write. The Great Gatsby was born in an age of prosperity, parties and excess. They called it “the American Dream”.



Info

Description

Weight: 3.2 Kg

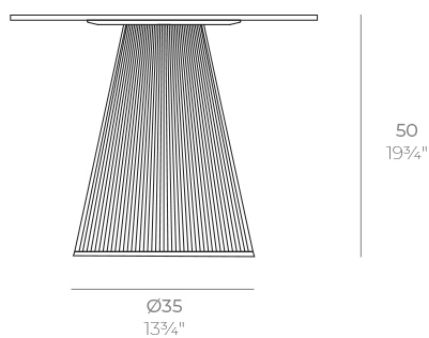

GATSBY Mesa Base Redonda Ø35x50cm S30
GATSBY Round Base Table Ø35x50cm S30
ref. 54448

TABLE TOP - SOBRE

- Ø50 cm
Ø19¹/₄"
- Ø59 cm
Ø23¹/₄"
- Ø69 cm
Ø27¹/₄"

Accessories

- TABLE 10mm
- TABLE 12mm
- TABLE DEKTON

Finishes

finishes

BASIC

Ref. 54448



purjai red



orange



ice



notte blue



crema

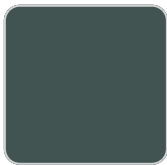

green



white



black



bronze



steel



anthracite



red



khaki



taupe



ecru



beige

Matt Polyethylene

Products / Low Tables / Gatsby Base ø35x50cm S50

Gatsby base ø35x50cm s50

by Ramón Esteve

The Gatsby collection, designed by Ramón Esteve for Vondom, recalls the Art Déco lighting. Those crazy twenties. “Something new, extraordinary, beautiful, simple but sophisticatedly designed” said Francis Scott Fitzgerald about his aims for the novel he was about to write. The Great Gatsby was born in an age of prosperity, parties and excess. They called it “the American Dream”.



Info

Description

Weight: 3.2 Kg

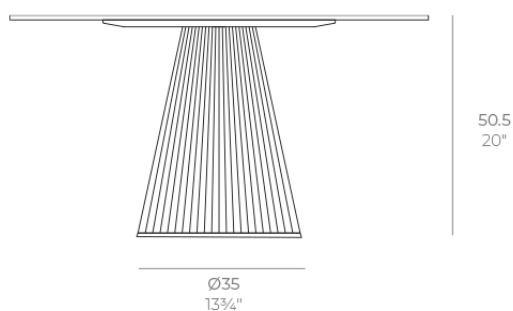

GATSBY Mesa Base Redonda Ø35x50.5cm S50
GATSBY Round Base Table Ø35x50.5cm S50
ref. 54449

TABLE TOP - SOBRE

- Ø79 cm
Ø31"
- Ø89 cm
Ø35"
- Ø100 cm
Ø39 1/4"

Accessories

- TABLE 10mm
- TABLE 12mm
- TABLE DEKTON

Finishes

finishes

BASIC

Ref. 54449



crema

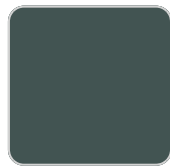

green

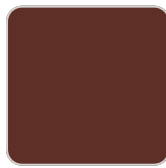

purjai red



orange

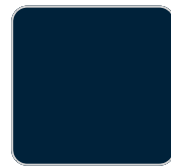

notte blue



ice



white



black



bronze



steel



anthracite



red



khaki



taupe



ecru



beige

Matt Polyethylene

Products / Low Tables / Gatsby Base 30x30x50cm S30

Gatsby base 30x30x50cm s30

by Ramón Esteve

The Gatsby collection, designed by Ramón Esteve for Vondom, recalls the Art Déco lighting. Those crazy twenties. “Something new, extraordinary, beautiful, simple but sophisticatedly designed” said Francis Scott Fitzgerald about his aims for the novel he was about to write. The Great Gatsby was born in an age of prosperity, parties and excess. They called it “the American Dream”.

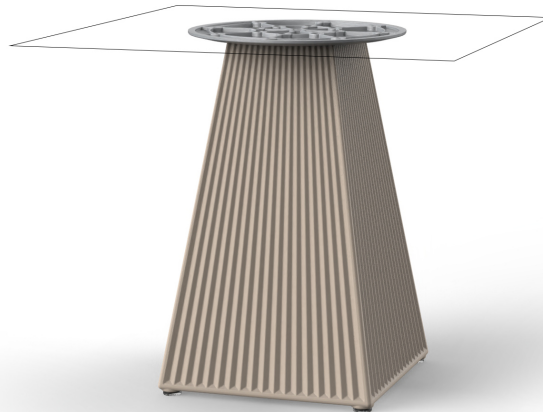

Info

Description

Weight: 4.4 Kg

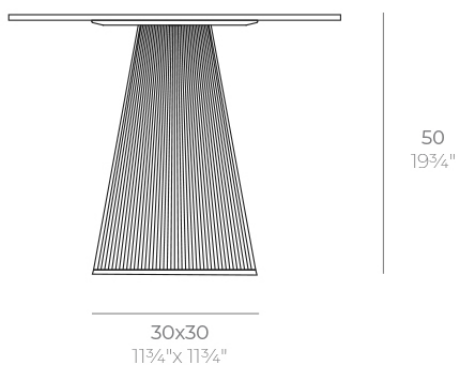

GATSBY Mesa Base Cuadrada 30x30x50cm S30
GATSBY Square Base Table 30x30x50cm S30
ref. 54450

TABLE TOP - SOBRE

■	50 x 50 cm 19 ¹ / ₄ " x 19 ¹ / ₄ "
■	59 x 59 cm 23 ¹ / ₄ " x 23 ¹ / ₄ "

Accessories

- TABLE 10mm
- TABLE 12mm
- TABLE DEKTON

Finishes

finishes

BASIC

Ref. 54450



ice



notte blue



crema

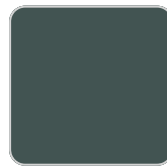

green

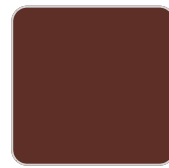

purjai red



orange



white



black



bronze



steel



anthracite



red



khaki



taupe



ecru



beige

Matt Polyethylene

Products / Low Tables / Gatsby Base 30x30x50cm S50

Gatsby base 30x30x50cm s50

by Ramón Esteve

The Gatsby collection, designed by Ramón Esteve for Vondom, recalls the Art Déco lighting. Those crazy twenties. “Something new, extraordinary, beautiful, simple but sophisticatedly designed” said Francis Scott Fitzgerald about his aims for the novel he was about to write. The Great Gatsby was born in an age of prosperity, parties and excess. They called it “the American Dream”.

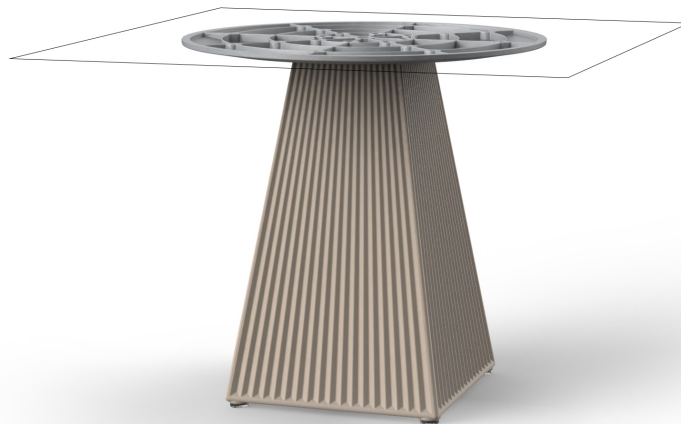

Info

Description

Weight: 4.4 Kg

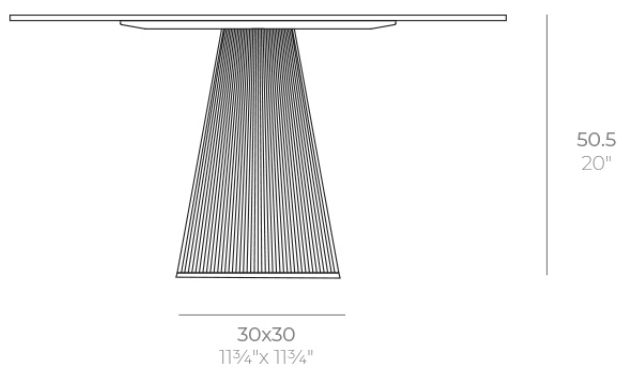

GATSBY Mesa Base Cuadrada 30x30x50.5cm S50
GATSBY Square Base Table 30x30x50.5cm S50
ref. 54451

TABLE TOP - SOBRE

■	69 x 69 cm 27 ¹ / ₄ " x 27 ¹ / ₄ "
■	79 x 79 cm 31" x 31"

Accessories

- TABLE 10mm
- TABLE 12mm
- TABLE DEKTON

Finishes

finishes

BASIC

Ref. 54451



orange

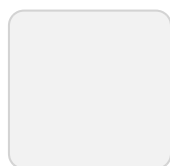

ice



notte blue

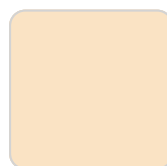

crema



green



purjai red



white



black



bronze



steel



anthracite



red



khaki



taupe



ecru



beige

Matt Polyethylene

Products / Low Tables / Gatsby Base ø40x25 S30

Gatsby base ø40x25 s30

by Ramón Esteve

The Gatsby collection, designed by Ramón Esteve for Vondom, recalls the Art Déco lighting. Those crazy twenties. “Something new, extraordinary, beautiful, simple but sophisticatedly designed” said Francis Scott Fitzgerald about his aims for the novel he was about to write. The Great Gatsby was born in an age of prosperity, parties and excess. They called it “the American Dream”.

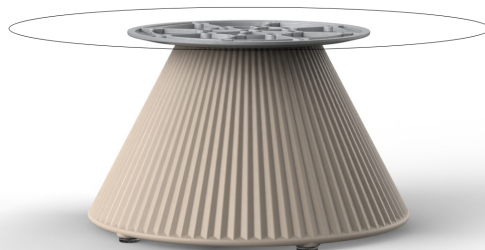

Info

Description

Weight: 2.38 Kg

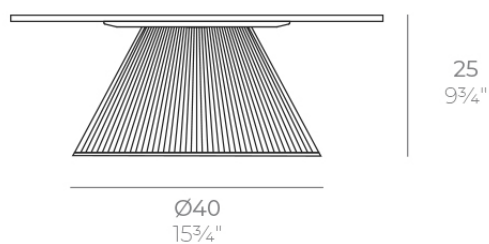

GATSBY Mesa Base Redonda Ø40x25cm S30
GATSBY Round Base Table Ø40x25cm S30
ref. 54440

TABLE TOP - SOBRE

- Ø50 cm
Ø19 1/4"
- Ø59 cm
Ø23 1/4"
- Ø69 cm
Ø27 1/4"

Accessories

- TABLE 10mm
- TABLE 12mm
- TABLE DEKTON

Finishes

finishes

BASIC

Ref. 54440



crema

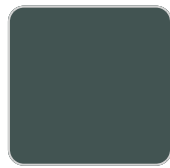

green

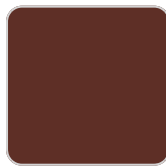

purjai red



orange

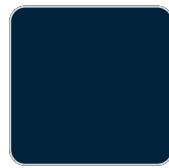

notte blue



ice



white



black



bronze



steel



anthracite



red



khaki



taupe



ecru



beige

Matt Polyethylene

Ambients

