

# Gatsby modular

by Ramón Esteve

The Gatsby collection, designed by Ramón Esteve for Vondom, recalls the Art Déco lighting. Those crazy twenties. “Something new, extraordinary, beautiful, simple but sophisticatedly designed” said Francis Scott Fitzgerald about his aims for the novel he was about to write. The Great Gatsby was born in an age of prosperity, parties and excess. They called it “the American Dream”.



# Info

---

## Description

Made of polyethylene resin by rotational moulding. 100% Recyclable. Item suitable for indoor and outdoor use. Available in different finishes.

# Modules

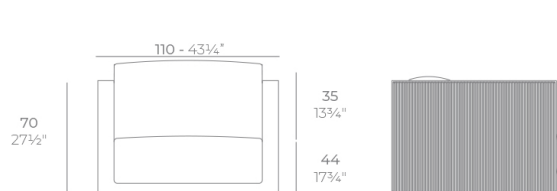

GATSBY Butaca  
GATSBY Armchair  
ref. 54403

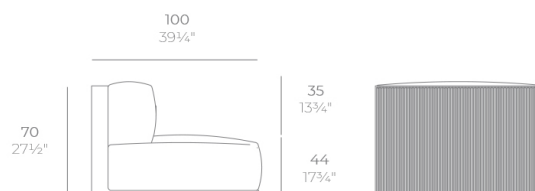

GATSBY Sofá Módulo Central  
GATSBY Sectional Sofa Armless  
ref. 54404

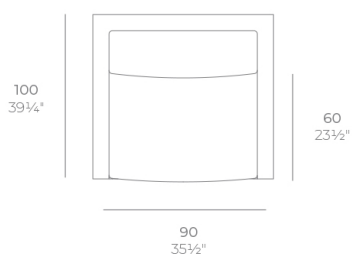

GATSBY Sofá Módulo Derecho  
GATSBY Sectional Sofa Right  
ref. 54405

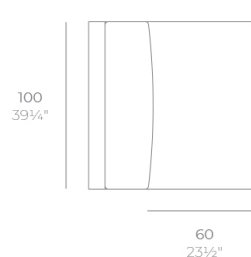

GATSBY Sofá Módulo Izquierdo  
GATSBY Sectional Sofa Left  
ref. 54406

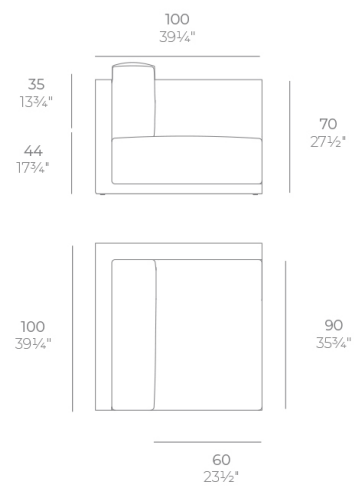
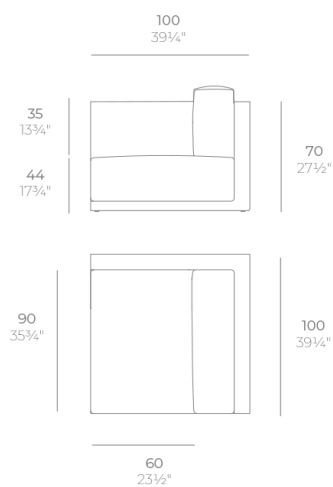

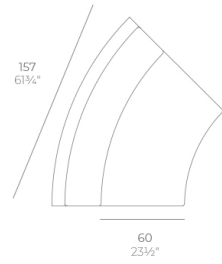
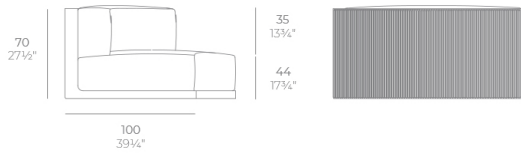

GATSBY Sofá Módulo Circular 45°  
GATSBY Sectional Sofa Curved 45°  
ref. 54407

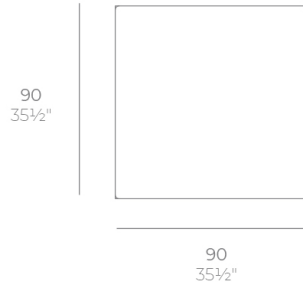
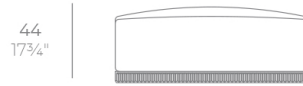

GATSBY Puff-Chaise Longue  
GATSBY Ottoman-Chaise Longue  
ref. 54408

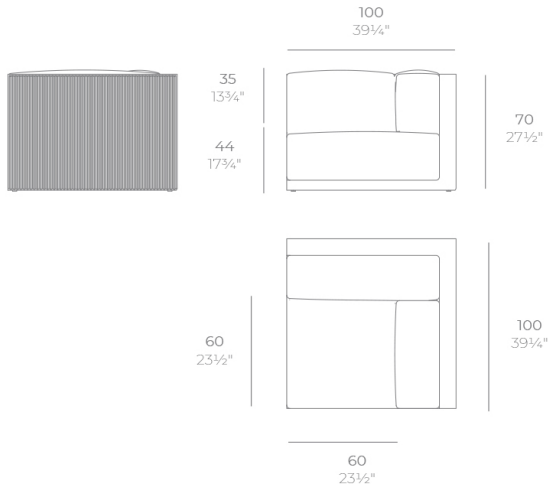

GATSBY Sofá Módulo Esquina Izquierda  
GATSBY Sectional Sofa Left Corner  
ref. 54411

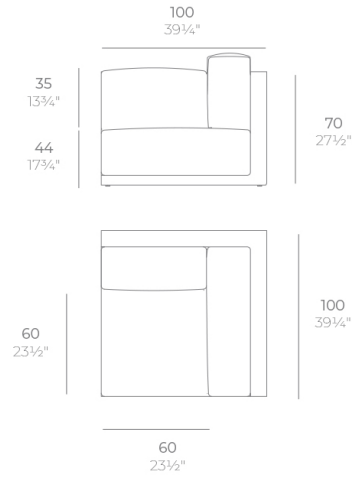

GATSBY Sofá Módulo Esquina Derecha  
GATSBY Sectional Right Corner  
ref. 54420

# Finishes

---

## finishes

---

### BASIC



orange

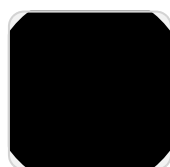

ice



notte blue



crema

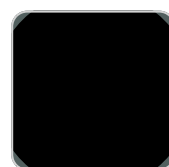

green



purjai red



white



black



bronze



steel



anthracite



red



khaki



taupe



ecru



beige

### Matt Polyethylene

## fabric

---

### GLAD



oro 1031



ocre 1051

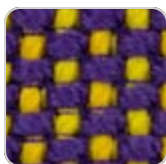

sunset 1020



delhi 1038



lima 1030



aguacate 1028



caribe 1004



bosc 1029

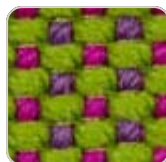

artemisa 1027

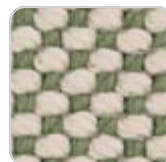

oasis 1007



oceano 1005



pruna 1045



noa 1026



berry 1021



amatista 1011



vera 1019



afrodita 1013



grana 1046



bacco 1034



dahlia 1035



wine 1012



foc 1052



hestia 1014



turquoise 1053

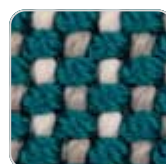

niord 1015



masai 1018



ultramar 1002



aquamarina 1003

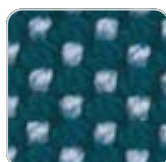

esmeralda 1016

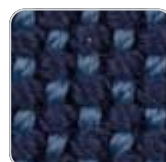

night 1024

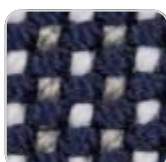

galan 1025



eclipse 1023

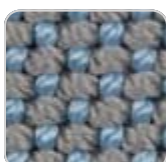

perla 1006



calipso 1017



snow 1041

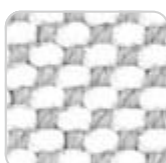

iceberg 1037



steel 1042

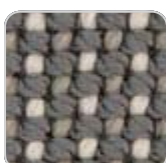

moon 1040



granito 1008

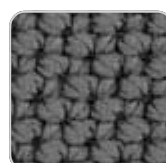

grey 1043



anthracite 1044



ecru 1047



dessert 1033



taupe 1048



terra 1039



duna 1009



moka 1010



chocolate 1050

Soft and cozy fabric suitable for indoor and outdoor use.

## NAUTIC

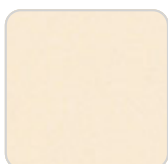

crema 1103



red 1108

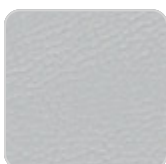

steel 1101

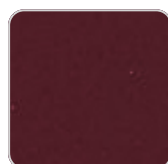

purjai red 1106

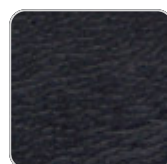

black 1105



notte blue 1114



orange 3115



orange 1113

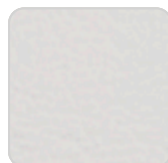

taupe 1102

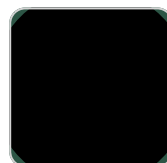

forest 1112



bronze 1104

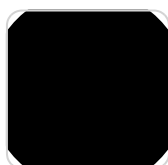

natural 1111

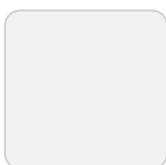

white 1100

Soft leather like fabric suitable for indoor and outdoor use. Standard option for upholstery.

## SILVERTEX



beige 1211



bronze 1214



khaki 1218



steel 1208



plum 2016

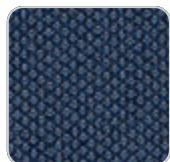

navy 3068



taupe 1209

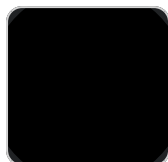

antrachite 1210

Vinyl fabric suitable for indoor and outdoor use. Special option for upholstery.

## CREVIN



white 1308



crevin 14



steel 1309



taupe 1310

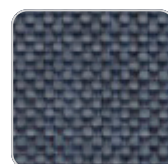

crevin 42

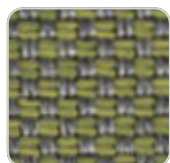

crevin 30

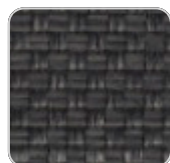

anthracite 1311

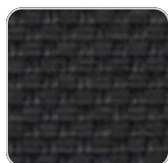

crevin 55

Upholstery fabric, that as and natural appearance and can be easy cleaned by washing machines, allowing an easy removal of mildew. Suitable for indoor and outdoor use

## CICO

Cozy fabric with an elegant look and soft touch.

## ACAPULCO

Cozy fabric with an elegant look and soft touch.



## SIESTA

Cozy fabric with an elegant look and soft touch.

## IKON

Cozy fabric with an elegant look and soft touch.

## HERITAGE



granite 1531

Outdoor fabrics are waterproof 50% recycled acrylic, 47% acrylic and 3% PE.

## SAVANE



white 1501



tornado 1503



whisper 1502

Outdoor fabrics are waterproof 100% acrylic.

# Ambients

---

