

# THEO TABLE

---

The Theo Table range is suitable for meeting or dining and is available with round, square or rectangular tops in either veneer or laminate finishes.

Exposed plywood or solid edges are clear lacquered, stained, or solid coloured.  
A subtle cut-back convex profile visually reduces the edge thickness and enhances the aesthetics.



Stain & colour options



10 year guarantee



Made with FSC approved wood



# THEO TABLE

## Standard Wood Finishes

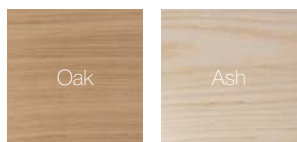

## Table Laminates

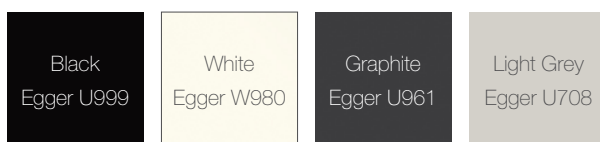

## Stains

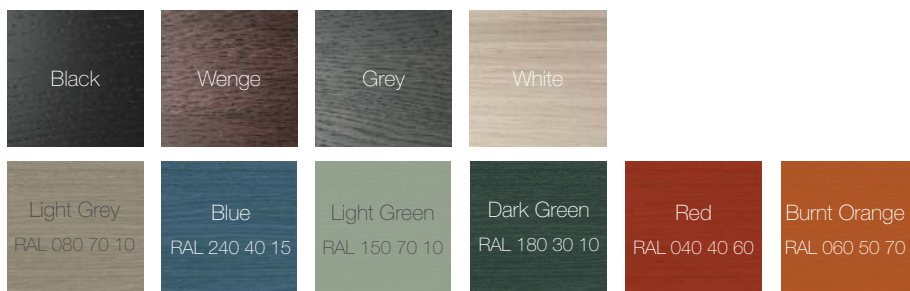

Theo table round  
diameter 750  
height 740

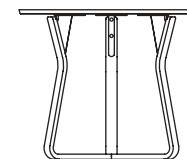

Theo table round  
diameter 900/1050/1200  
height 740

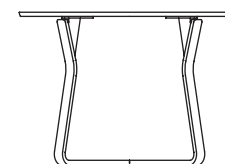

Theo table square  
length/width 750 x 750  
length/width 900 x 900  
height 740

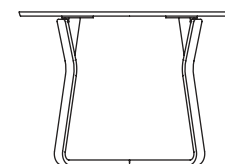

Theo table rectangle  
length/width 1400 x 750  
length/width 1800 x 750  
length/width 1800 x 900  
height 740

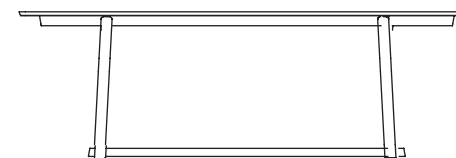

Theo table rectangle  
length/width 2400 x 750  
length/width 3000 x 1000  
height 740

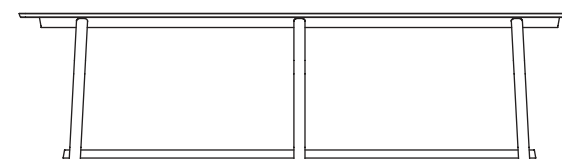

# THEO TABLE



# THEO TABLE



# THEO TABLE



# THEO TABLE



# THEO TABLE

---



# THEO EXTENDING TABLE

---

Designed by British designer Simon Pengelly, the Theo Extending Table is a lightweight, strong, durable wood framed table. Perfect for breakout spaces, cafe areas and informal meetings, the Theo Extending Table is complemented by a range of matching family products including chairs, credenzas, stools and benches.



Stain & colour options



10 year guarantee



Made with FSC approved wood





# THEO EXTENDING TABLE

---

## Standard Wood Finishes

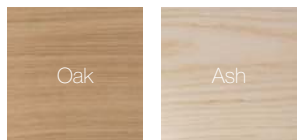

## Table Laminates

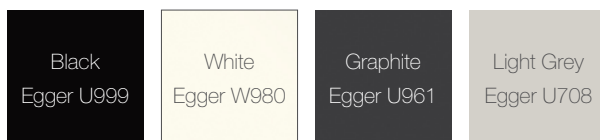

## Stains

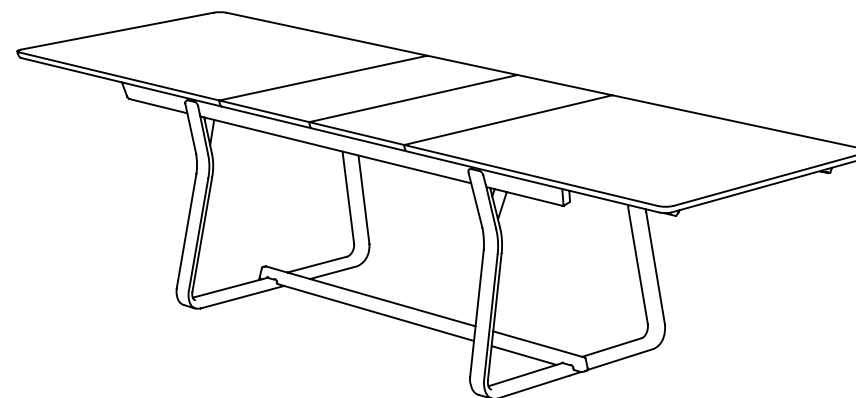
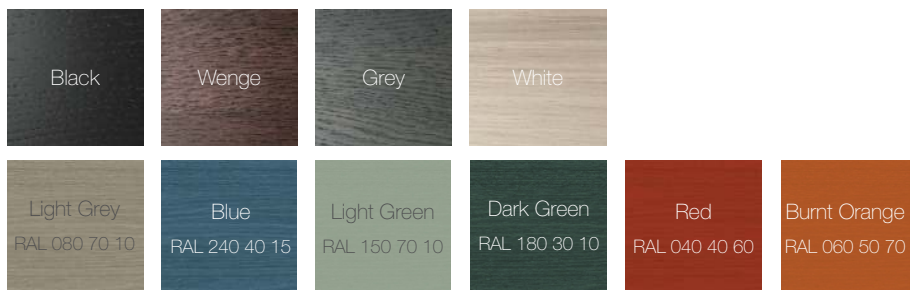

Extending Table  
900mm x (2000 - 2800mm) x 740mm

# THEO EXTENDING TABLE

---



# THEO EXTENDING TABLE

---



# THEO EXTENDING TABLE



# THEO EXTENDING TABLE

---

