

Valentina Seating System Specification Guide**Standard Features**

Valentina is a modular seating system comprised of 6 unique modules which can be used interchangeably to create an unlimited number of configurations. All modules can also be used as freestanding units.

Valentina features new contrasting fabric options and comes standard with welt and a saddle stitch detail on the seat, back and arm.

Configurations are connected by a ganging bracket. Ganging brackets are included with each module. 1½" diameter non-marring adjustable glide.

When ordering configurations, please provide the total COM yardage from the same dye lot in a continuous roll(s). All COM/COL fabrics must be preapproved by Bernhardt Design prior to application. SCS Indoor Advantage™ Gold certified. See terms and conditions for additional finish and environmental information.

Please visit Bernhardtdesign.com for a complete library of 2D, 3D, and Revit models. You may also contact your local sales representative or the Bernhardt Design Corporate office for specification assistance.

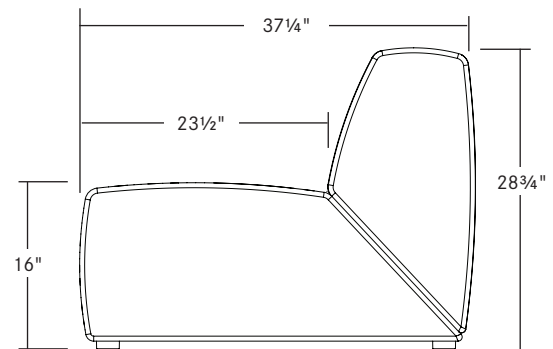

Side view of sku 5650

1½" Diameter Non-Marring Adjustable Nylon Glides

Valentina Contrasting Fabric Options

Valentina modular seating offers three contrasting fabric options.

- A. Inside seat and back, top and side panels of the arms.
- B. Seat and back side panels, front and back panels of the arms.
- C. Welt

*All COM/COL fabrics must be preapproved by Bernhardt Design prior to application. When ordering multi-item configurations, provide the total COM yardage from the same dye lot in a continuous roll(s). See terms and conditions for instructions for tagging COM.

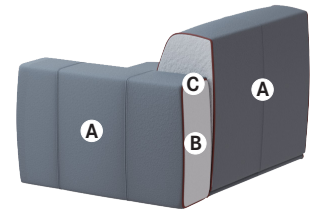
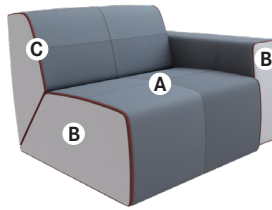

Valentina Seating System Sample Configurations

1

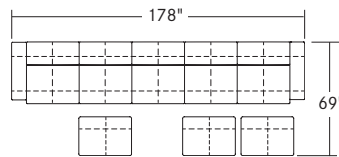
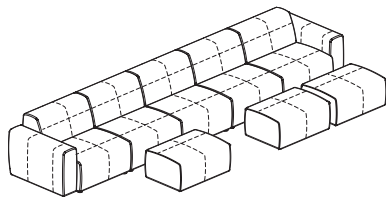

SKU Description

- 5651** Single Seat. Left Arm Facing Module
- 5650** (3) Single Seat Modules. Armless
- 5652** Single Seat. Right Arm Facing Module
- 5655** (3) Ottomans

2

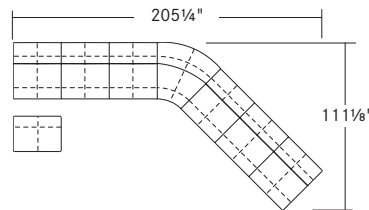
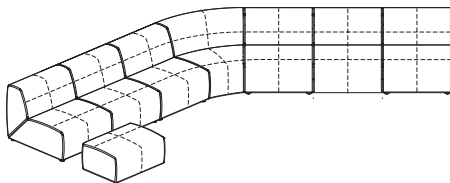

- 5650** (3) Single Seat Modules. Armless
- 5654** 45° Connector
- 5650** (3) Single Seat Modules. Armless
- 5655** Ottoman

3

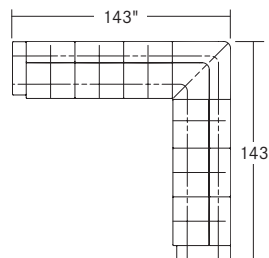
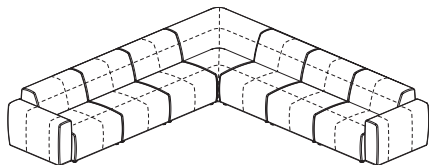

- 5651** Single Seat. Left Arm Facing Module
- 5650** (2) Single Seat Modules. Armless
- 5653** 90° Corner Connector
- 5650** (2) Single Seat Modules. Armless
- 5652** Single Seat. Right Arm Facing Module

4

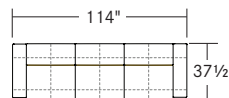
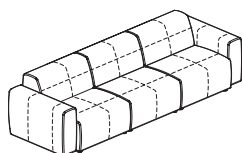

- 5651** Single Seat. Left Arm Facing Module
- 5650** Single Seat Module. Armless
- 5652** Single Seat. Right Arm Facing Module

valentina 5650

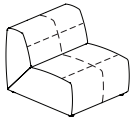

| Seat Height | Arm Height | W | | D | | H | | Fabric | Leather | Weight | Cubes/Qty | |
|-------------|------------|--------|---|--------|---|--------|---|--------|----------|-----------|-----------|----|
| 16" | - | 32¾" | | 37¼" | | 28¾" | | 7 yds. | 113.0' | 91 lbs. | 32.10'/1 | |
| 406 mm | - | 832 mm | | 947 mm | | 731 mm | | 6.4 m | 10.5 sqm | 41.27 kg. | .91 cu. | |
| COM | COL | 1 | 2 | 3 | 4 | 5 | 6 | 7 | 8 | 9 | 10 | 11 |

Single Seat Module. Armless. Fully Upholstered.

Saddle stitch detail on seat and back and welt come standard. Ganging brackets included.

When using a combination of fabrics or leathers, the following yardage must be used and upcharges apply. Specify the fabric or leather application by designating the appropriate letter on the purchase order.

See terms and conditions for contrasting fabric upcharges.

A) One fabric or leather for inside seat and back.

yardage: 4.25 yds. leather: 69.0 sq. ft.

B) One fabric or leather for seat and back sides panels.

yardage: 1.75 yds. leather: 28.0 sq. ft.

C) One fabric or leather for welt.

yardage: 1.0 yd. leather: 16.0 sq. ft.

When ordering multi-item configurations, please provide the total COM yardage from the same dye lot in a continuous roll(s). *All COM/COL fabrics must be preapproved by Bernhardt Design prior to application. SCS Indoor Advantage™ Gold certified. See terms and conditions for instructions for tagging COM and additional environmental information.

valentina 5651

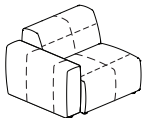

| | | | | | | | | | | | | |
|--------|--------|--------|---|--------|---|--------|---|-----------|----------|-----------|----------|----|
| 16" | 23" | 32¾" | | 37¼" | | 28¾" | | 9.25 yds. | 149.0' | 129 lbs. | 45.85'/1 | |
| 406 mm | 585 mm | 832 mm | | 947 mm | | 731 mm | | 8.5 m | 13.9 sqm | 58.51 kg. | 1.30 cu. | |
| COM | COL | 1 | 2 | 3 | 4 | 5 | 6 | 7 | 8 | 9 | 10 | 11 |

Single seat. Left Arm Facing Module. Fully Upholstered.

Saddle stitch detail on seat and back and welt come standard. Ganging brackets included.

When using a combination of fabrics or leathers, the following yardage must be used and upcharges apply. Specify the fabric or leather application by designating the appropriate letter on the purchase order.

See terms and conditions for contrasting fabric upcharges.

A) One fabric or leather for inside seat and back, top and side panels of the arm.

yardage: 6.5 yds. leather: 105.0 sq. ft.

B) One fabric or leather for seat and back side panels, front and back panels of the arm.

yardage: 1.75 yds. leather: 28.0 sq. ft.

C) One fabric or leather for welt.

yardage: 1.0 yd. leather: 16.0 sq. ft.

When ordering multi-item configurations, please provide the total COM yardage from the same dye lot in a continuous roll(s). *All COM/COL fabrics must be preapproved by Bernhardt Design prior to application. SCS Indoor Advantage™ Gold certified. See terms and conditions for instructions for tagging COM and additional environmental information.

valentina 5652

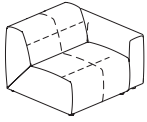

| Seat Height | Arm Height | W | | D | | H | | Fabric | Leather | Weight | Cubes/Qty | |
|-------------|------------|--------|---|--------|---|--------|---|-----------|----------|-----------|-----------|----|
| 16" | 23" | 32¾" | | 37¼" | | 28¾" | | 9.25 yds. | 149.0' | 129 lbs. | 45.85'/1 | |
| 406 mm | 585 mm | 832 mm | | 947 mm | | 731 mm | | 8.5 m | 13.9 sqm | 58.51 kg. | 1.30 cu. | |
| COM | COL | 1 | 2 | 3 | 4 | 5 | 6 | 7 | 8 | 9 | 10 | 11 |

Single Seat. Right Arm Facing Module. Fully Upholstered.

Saddle stitch detail on seat and back and welt come standard. Ganging brackets included.

When using a combination of fabrics or leathers, the following yardage must be used and upcharges apply. Specify the fabric or leather application by designating the appropriate letter on the purchase order.

See terms and conditions for contrasting fabric upcharges.

- A) One fabric or leather for inside seat and back, top and side panels of the arm.
yardage: 6.5 yds. leather: 105.0 sq. ft.
- B) One fabric or leather for seat and back side panels, front and back panels of the arms.
yardage: 1.75 yds. leather: 28.0 sq. ft.
- C) One fabric or leather for welt.
yardage: 1.0 yd. leather: 16.0 sq. ft.

When ordering multi-item configurations, please provide the total COM yardage from the same dye lot in a continuous roll(s). *All COM/COL fabrics must be preapproved by Bernhardt Design prior to application. SCS Indoor Advantage™ Gold certified. See terms and conditions for instructions for tagging COM and additional environmental information.

valentina 5653



| | | | | | | | | | | | | |
|--------|-----|--------|---|--------|---|--------|---|-----------|----------|-----------|----------|----|
| 16" | - | 38½" | | 38½" | | 28¾" | | 7.75 yds. | 127 .0' | 128 lbs. | 45.85'/1 | |
| 406 mm | - | 978 mm | | 978 mm | | 731 mm | | 7.1 m | 11.8 sqm | 58.06 kg. | 1.30 cu. | |
| COM | COL | 1 | 2 | 3 | 4 | 5 | 6 | 7 | 8 | 9 | 10 | 11 |

90° Connector. Fully Upholstered

Saddle stitch detail on seat and back and welt come standard. Ganging brackets included.

When using a combination of fabrics or leathers, the following yardage must be used and upcharges apply. Specify the fabric or leather application by designating the appropriate letter on the purchase order.

See terms and conditions for contrasting fabric upcharges.

- A) One fabric or leather for inside seat and back.
yardage: 4.25 yds. leather: 69.0 sq. ft.
- B) One fabric or leather for seat and back side panels.
yardage: 2.5 yds. leather: 42.0 sq. ft.
- C) One fabric or leather for welt.
yardage: 1.0 yd. leather: 16.0 sq. ft.

When ordering multi-item configurations, please provide the total COM yardage from the same dye lot in a continuous roll(s). *All COM/COL fabrics must be preapproved by Bernhardt Design prior to application. SCS Indoor Advantage™ Gold certified. See terms and conditions for instructions for tagging COM and additional environmental information.

valentina 5654

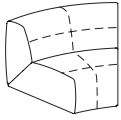

| Seat Height | Arm Height | W | | D | | H | | Fabric | Leather | Weight | Cubes/Qty | |
|-------------|------------|---------|---|---------|---|--------|---|-----------|----------|-----------|-----------|----|
| 16" | - | 45½" | | 40" | | 28¾" | | 6.75 yds. | 109.0' | 128 lbs. | 32.10'/1 | |
| 406 mm | - | 1156 mm | | 1016 mm | | 731 mm | | 6.2 m | 10.2 sqm | 58.06 kg. | .91 cu. | |
| COM | COL | 1 | 2 | 3 | 4 | 5 | 6 | 7 | 8 | 9 | 10 | 11 |

45° Connector. Fully Upholstered.

Saddle stitch detail on seat and back and welt come standard. Ganging brackets included.

When using a combination of fabrics or leathers, the following yardage must be used and upcharges apply. Specify the fabric or leather application by designating the appropriate letter on the purchase order.

See terms and conditions for contrasting fabric upcharges.

- A) One fabric or leather for inside seat and back.
yardage: 4.0 yds. leather: 65.0 sq. ft.
- B) One fabric or leather for seat and back side panels.
yardage: 1.75 yds. leather: 28.0 sq. ft.
- C) One fabric or leather for welt.
yardage: 1.0 yd. leather: 16.0 sq. ft.

When ordering multi-item configurations, please provide the total COM yardage from the same dye lot in a continuous roll(s). *All COM/COL fabrics must be preapproved by Bernhardt Design prior to application. SCS Indoor Advantage™ Gold certified. See terms and conditions for instructions for tagging COM and additional environmental information.

valentina 5655



| | | | | | | | | | | | | |
|-----|-----|--------|---|--------|---|--------|---|----------|---------|-----------|----------|----|
| - | - | 32" | | 23½" | | 15¼" | | 4.8 yds. | 78.0' | 45 lbs. | 15.31'/1 | |
| - | - | 813 mm | | 597 mm | | 388 mm | | 4.4 m | 7.3 sqm | 20.41 kg. | .44 cu. | |
| COM | COL | 1 | 2 | 3 | 4 | 5 | 6 | 7 | 8 | 9 | 10 | 11 |

Ottoman. Fully Upholstered.

Saddle stitch detail on seat and back and welt come standard.

When using a combination of fabrics or leathers, the following yardage must be used and upcharges apply. Specify the fabric or leather application by designating the appropriate letter on the purchase order.

See terms and conditions for contrasting fabric upcharges.

- A) One fabric or leather for top seat panel and upper body.
yardage: 2.25 yds. leather: 37.0 sq. ft.
- B) One fabric or leather for lower body
yardage: 1.5 yds. leather: 25.0 sq. ft.
- C) One fabric or leather for welt.
yardage: 1.0 yd. leather: 16.0 sq. ft.

When ordering multi-item configurations, please provide the total COM yardage from the same dye lot in a continuous roll(s). *All COM/COL fabrics must be preapproved by Bernhardt Design prior to application. SCS Indoor Advantage™ Gold certified. See terms and conditions for instructions for tagging COM and additional environmental information.

| | Seat Height | Arm Height | W | D | H | Fabric | Leather | Weight | Cubes/Qty | | | | |
|------------------------------|-------------|------------|--------|--------|--------|--------|---------|--------|-----------|---|---|----|----|
| 4PD decorative pillow | - | - | 16½" | 4" | 16½" | 1 yd. | 18.0' | 8 lbs. | .89/1 | | | | |
| | - | - | 419 mm | 102 mm | 419 mm | .91 m | 1.7 sqm | 3.6 kg | .03 cu. | | | | |
| | COM | COL | 1 | 2 | 3 | 4 | 5 | 6 | 7 | 8 | 9 | 10 | 11 |



½" Panel Border Pillow.

All COM/COL fabrics must be preapproved by Bernhardt Design prior to application.