

## Alloro Seating System Specification Guide

### Standard Features



Alloro is a modular seating system comprised of 35 unique modules which can be used interchangeably to create an unlimited number of configurations. Options include sofas or modular sectionals along with straight and flared fronts.

Alloro backs are constructed of fiberglass and come standard with an attached back cushion. Alloro modules are available with contrasting fabric options, please see pricing pages for details.

Alloro is fully upholstered with 2¼" diameter non-marring adjustable glide. When ordering configurations, please provide the total COM yardage from the same dye lot in a continuous roll(s). All COM/COL fabrics must be preapproved by Bernhardt Design prior to application. SCS Indoor Advantage™ Gold certified. See terms and conditions for additional environmental information.

Configurations are connected by a ganging bracket. Ganging brackets are included with each module.

Please visit [Bernhardtdesign.com](http://Bernhardtdesign.com) for a complete library of 2D, 3D, and Revit models. You may also contact your local sales representative or the Bernhardt Design Corporate office for specification assistance.

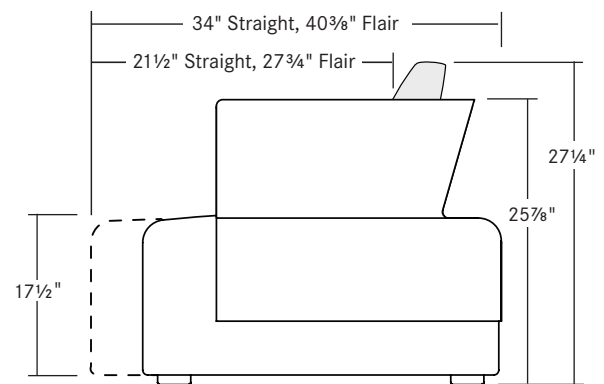

**Side view of sku 4F37SX**

2¼" Diameter Non-Marring Adjustable Nylon Glides

**Alloro Connecting**

Alloro modular units connect together either on the end, on both sides or on the corner. The price list uses grey areas within the product illustrations to indicate the connecting areas of each unit. To the right is a sample illustration indicating the connecting areas for the products shown.

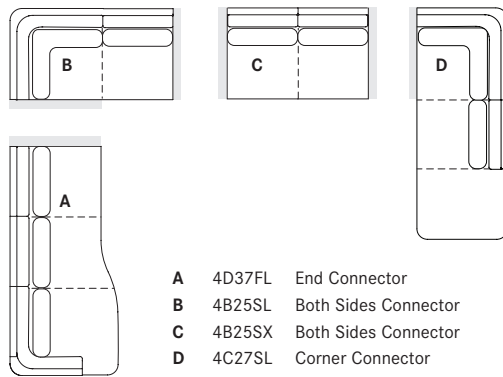

- A** 4D37FL End Connector
- B** 4B25SL Both Sides Connector
- C** 4B25SX Both Sides Connector
- D** 4C27SL Corner Connector

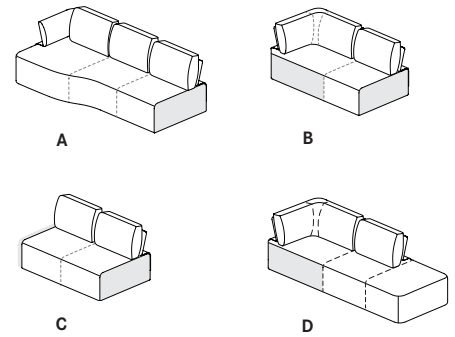

**Alloro Seating System Sample Configurations**

	Sku	Description
<p>1</p>	<p><b>4D37FL</b></p> <p><b>4C27SL</b></p>	<p>Three-seat End Connector. Left Arm Facing. Flared Front.</p> <p>Three-seat Corner Connector. Left Arm Facing. Straight Front.</p>
<p>2</p>	<p><b>4D37SL</b></p> <p><b>4C27SL</b></p>	<p>Three-seat End Connector. Left Arm Facing. Straight Front.</p> <p>Three-seat Corner Connector. Left Arm Facing. Straight Front.</p>
<p>3</p>	<p><b>4D37FL</b></p> <p><b>4B25SL</b></p> <p><b>4D37FR</b></p>	<p>Three-seat End Connector. Left Arm Facing. Flared Front.</p> <p>Two-seat Connector. Left Arm Facing. Straight Front.</p> <p>Three-seat End Connector. Right Arm Facing. Flared Front.</p>
<p>4</p>	<p><b>4D37SL</b></p> <p><b>4D37SR</b></p>	<p>Three-seat End Connector. Left Arm Facing. Straight Front.</p> <p>Three-seat End Connector. Right Arm Facing. Straight Front.</p>

freestanding modules

**alloro 4F25SX**

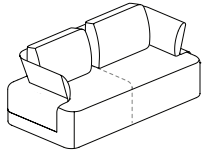

Seat Height	Arm Height	W		D		H		Fabric	Leather	Weight	Cubes/Qty	
17½"	11"	66½"		34"		27¼"		14.5 yds.	236.0'	205 lbs.	56.06'/1	
445 mm	280 mm	1690 mm		864 mm		690 mm		13.3 m	22.0 sqm	93.0 kg	1.6 cu	
COM	COL	1	2	3	4	5	6	7	8	9	10	11

Two-Seat Freestanding.  
Straight Front Module.  
Fully Upholstered.  
Two Back Cushions.

Inside Seat Width: 52½". Inside Seat Depth: 21½".

When using a combination of fabrics or leathers, the following yardage must be used and upcharges apply. Specify the fabric or leather application by designating the appropriate letter on the purchase order.

See terms and conditions for contrasting fabric upcharges.

- A) One fabric or leather for seat.  
yardage: 4.5 yds. leather: 73.0 sq. ft.
- B) One fabric or leather for back.  
yardage: 6.5 yds. leather: 106.0 sq. ft.
- C) One fabric or leather for back cushion.  
yardage: 3.5 yds. leather: 57.0 sq. ft.

When ordering multi-item configurations, please provide the total COM yardage from the same dye lot in a continuous roll(s).  
\*All COM/COL fabrics must be preapproved by Bernhardt Design prior to application. SCS Indoor Advantage™ Gold certified.  
See terms and conditions for instructions for tagging COM and additional environmental information.

**alloro 4F37SX**

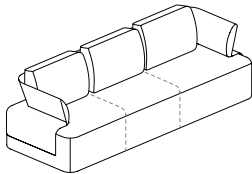

Seat Height	Arm Height	W		D		H		Fabric	Leather	Weight	Cubes/Qty	
17½"	11"	93⅞"		34"		27¼"		20.0 yds.	321.0'	290 lbs.	89.84'/1	
445 mm	280 mm	2340 mm		864 mm		690 mm		18.3 m	30.0 sqm	132 kg	2.5 cu	
COM	COL	1	2	3	4	5	6	7	8	9	10	11

Three-Seat Freestanding.  
Straight Front Module.  
Fully Upholstered.  
Three Back Cushions.

Inside Seat Width: 52½". Inside Seat Depth: 21½".

When using a combination of fabrics or leathers, the following yardage must be used and upcharges apply. Specify the fabric or leather application by designating the appropriate letter on the purchase order.

See terms and conditions for contrasting fabric upcharges.

- A) One fabric or leather for seat.  
yardage: 6.5 yds. leather: 106.0 sq. ft.
- B) One fabric or leather for back.  
yardage: 8.0 yds. leather: 130.0 sq. ft.
- C) One fabric or leather for back cushion.  
yardage: 5.5 yds. leather: 85.0 sq. ft.

When ordering multi-item configurations, please provide the total COM yardage from the same dye lot in a continuous roll(s).  
\*All COM/COL fabrics must be preapproved by Bernhardt Design prior to application. SCS Indoor Advantage™ Gold certified.  
See terms and conditions for instructions for tagging COM and additional environmental information.

freestanding modules

**alloro 4F37FL**

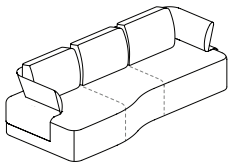

Seat Height	Arm Height	W		D		H		Fabric	Leather	Weight	Cubes/Qty	
17½"	11"	93⅝"		40⅝"		27¼"		20.8 yds.	333.0'	295 lbs.	89.84/1	
445 mm	280 mm	2340 mm		1026 mm		690 mm		19.0 m	31.0 sqm	133.8 kg	2.5 cu	
COM	COL	1	2	3	4	5	6	7	8	9	10	11

Three-Seat Freestanding.  
Left Side Flared Front Module.  
Fully Upholstered.  
Three Back Cushions.

Inside Seat Width: 78¾". Inside Seat Depth: 27¾".

When using a combination of fabrics or leathers, the following yardage must be used and upcharges apply. Specify the fabric or leather application by designating the appropriate letter on the purchase order.

See terms and conditions for contrasting fabric upcharges.

- A) One fabric or leather for seat.  
yardage: 7.25 yds. leather: 118.0 sq. ft.
- B) One fabric or leather for back.  
yardage: 8.0 yds. leather: 130.0 sq. ft.
- C) One fabric or leather for back cushion.  
yardage: 5.5 yds. leather: 85.0 sq. ft.

When ordering multi-item configurations, please provide the total COM yardage from the same dye lot in a continuous roll(s).  
\*All COM/COL fabrics must be preapproved by Bernhardt Design prior to application. SCS Indoor Advantage™ Gold certified.  
See terms and conditions for instructions for tagging COM and additional environmental information.

**alloro 4F37FR**

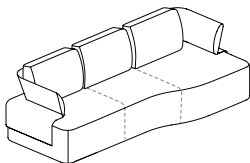

Seat Height	Arm Height	W		D		H		Fabric	Leather	Weight	Cubes/Qty	
17½"	11"	93⅝"		40⅝"		27¼"		20.8 yds.	333.0'	295 lbs.	89.84/1	
445 mm	280 mm	2340 mm		1026 mm		690 mm		19.0 m	31.0 sqm	133.8 kg	2.5 cu	
COM	COL	1	2	3	4	5	6	7	8	9	10	11

Three-Seat Freestanding.  
Right Side Flared Front Module.  
Fully Upholstered.  
Three Back Cushions.

Inside Seat Width: 78¾". Inside Seat Depth: 27¾".

When using a combination of fabrics or leathers, the following yardage must be used and upcharges apply. Specify the fabric or leather application by designating the appropriate letter on the purchase order.

See terms and conditions for contrasting fabric upcharges.

- A) One fabric or leather for seat.  
yardage: 7.25 yds. leather: 118.0 sq. ft.
- B) One fabric or leather for back.  
yardage: 8.0 yds. leather: 130.0 sq. ft.
- C) One fabric or leather for back cushion.  
yardage: 5.5 yds. leather: 85.0 sq. ft.

When ordering multi-item configurations, please provide the total COM yardage from the same dye lot in a continuous roll(s).  
\*All COM/COL fabrics must be preapproved by Bernhardt Design prior to application. SCS Indoor Advantage™ Gold certified.  
See terms and conditions for instructions for tagging COM and additional environmental information.

freestanding modules

**alloro 4F15SL**

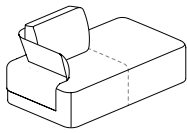

Seat Height	Arm Height	W	D	H	Fabric	Leather	Weight	Cubes/Qty				
17½"	11"	59½"	34"	27¼"	10.0 yds.	161.0'	203 lbs.	56.06'/1				
445 mm	280 mm	1515 mm	864 mm	690 mm	9.2 m	15.0 sqm	92.1 kg	1.6 cu				
COM	COL	1	2	3	4	5	6	7	8	9	10	11

Two-Seat Freestanding.  
Left Arm Facing Open Module.  
Straight Front.  
Fully Upholstered.  
One Back Cushion.

Inside Seat Width: 52½". Inside Seat Depth: 21½".

When using a combination of fabrics or leathers, the following yardage must be used and upcharges apply. Specify the fabric or leather application by designating the appropriate letter on the purchase order.

See terms and conditions for contrasting fabric upcharges.

- A) One fabric or leather for seat.  
yardage: 4.5 yds. leather: 73.0 sq. ft.
- B) One fabric or leather for back.  
yardage: 3.5 yds. leather: 57.0 sq. ft.
- C) One fabric or leather for back cushion.  
yardage: 2.0 yds. leather: 31.0 sq. ft.

When ordering multi-item configurations, please provide the total COM yardage from the same dye lot in a continuous roll(s).  
\*All COM/COL fabrics must be preapproved by Bernhardt Design prior to application. SCS Indoor Advantage™ Gold certified.  
See terms and conditions for instructions for tagging COM and additional environmental information.

**alloro 4F15SR**

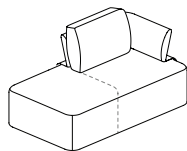

Seat Height	Arm Height	W	D	H	Fabric	Leather	Weight	Cubes/Qty				
17½"	11"	59½"	34"	27¼"	10.0 yds.	161.0'	203 lbs.	56.06'/1				
445 mm	280 mm	1515 mm	864 mm	690 mm	9.2 m	15.0 sqm	92.1 kg	1.6 cu				
COM	COL	1	2	3	4	5	6	7	8	9	10	11

Two-Seat Freestanding.  
Right Arm Facing Open Module.  
Straight Front.  
Fully Upholstered.  
One Back Cushion.

Inside Seat Width: 52½". Inside Seat Depth: 21½".

When using a combination of fabrics or leathers, the following yardage must be used and upcharges apply. Specify the fabric or leather application by designating the appropriate letter on the purchase order.

See terms and conditions for contrasting fabric upcharges.

- A) One fabric or leather for seat.  
yardage: 4.5 yds. leather: 73.0 sq. ft.
- B) One fabric or leather for back.  
yardage: 3.5 yds. leather: 57.0 sq. ft.
- C) One fabric or leather for back cushion.  
yardage: 2.0 yds. leather: 31.0 sq. ft.

When ordering multi-item configurations, please provide the total COM yardage from the same dye lot in a continuous roll(s).  
\*All COM/COL fabrics must be preapproved by Bernhardt Design prior to application. SCS Indoor Advantage™ Gold certified.  
See terms and conditions for instructions for tagging COM and additional environmental information.

freestanding modules

**alloro 4F17SL**

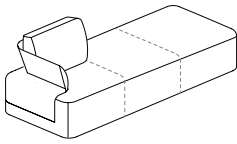

Seat Height	Arm Height	W		D		H		Fabric	Leather	Weight	Cubes/Qty	
17½"	11"	86"	34"	27¼"				12.0 yds.	194.0'	257 lbs.	77.86'/1	
445 mm	280 mm	2185 mm	864 mm	690 mm				11.0 m	18.0 sqm	116.6 kg	2.2 cu	
COM	COL	1	2	3	4	5	6	7	8	9	10	11

Three-Seat Freestanding.  
Left Arm Facing Open Module.  
Straight Front.  
Fully Upholstered.  
One Back Cushion.

Inside Seat Width: 78¾". Inside Seat Depth: 21½".

When using a combination of fabrics or leathers, the following yardage must be used and upcharges apply. Specify the fabric or leather application by designating the appropriate letter on the purchase order.

See terms and conditions for contrasting fabric upcharges.

- A) One fabric or leather for seat.  
yardage: 6.5 yds. leather: 106.0 sq. ft.
- B) One fabric or leather for back.  
yardage: 3.5 yds. leather: 57.0 sq. ft.
- C) One fabric or leather for back cushion.  
yardage: 2.0 yds. leather: 31.0 sq. ft.

When ordering multi-item configurations, please provide the total COM yardage from the same dye lot in a continuous roll(s).  
\*All COM/COL fabrics must be preapproved by Bernhardt Design prior to application. SCS Indoor Advantage™ Gold certified.  
See terms and conditions for instructions for tagging COM and additional environmental information.

**alloro 4F17SR**

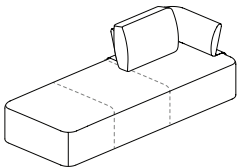

Seat Height	Arm Height	W		D		H		Fabric	Leather	Weight	Cubes/Qty	
17½"	11"	86"	34"	27¼"				12.0 yds.	194.0'	257 lbs.	77.86'/1	
445 mm	280 mm	2185 mm	864 mm	690 mm				11.0 m	18.0 sqm	116.6 kg	2.2 cu	
COM	COL	1	2	3	4	5	6	7	8	9	10	11

Three-Seat Freestanding.  
Right Arm Facing Open Module.  
Straight Front.  
Fully Upholstered.  
One Back Cushion.

Inside Seat Width: 78¾". Inside Seat Depth: 21½".

When using a combination of fabrics or leathers, the following yardage must be used and upcharges apply. Specify the fabric or leather application by designating the appropriate letter on the purchase order.

See terms and conditions for contrasting fabric upcharges.

- A) One fabric or leather for seat.  
yardage: 6.5 yds. leather: 106.0 sq. ft.
- B) One fabric or leather for back.  
yardage: 3.5 yds. leather: 57.0 sq. ft.
- C) One fabric or leather for back cushion.  
yardage: 2.0 yds. leather: 31.0 sq. ft.

When ordering multi-item configurations, please provide the total COM yardage from the same dye lot in a continuous roll(s).  
\*All COM/COL fabrics must be preapproved by Bernhardt Design prior to application. SCS Indoor Advantage™ Gold certified.  
See terms and conditions for instructions for tagging COM and additional environmental information.

freestanding modules

**alloro 4F27SL**

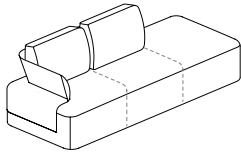

Seat Height	Arm Height	W		D		H		Fabric	Leather	Weight	Cubes/Qty	
17½"	11"	86"	34"	27¼"				15.0 yds.	244.0'	257 lbs.	77.86'/1	
445 mm	280 mm	2185 mm	864 mm	690 mm				14.0 m	23.0 sqm	116.6 kg	2.2 cu	
COM	COL	1	2	3	4	5	6	7	8	9	10	11

Three-Seat Freestanding.  
Left Arm Facing Open Module.  
Straight Front.  
Fully Upholstered.  
Two Back Cushions.

Inside Seat Width: 78¾". Inside Seat Depth: 21½".

When using a combination of fabrics or leathers, the following yardage must be used and upcharges apply. Specify the fabric or leather application by designating the appropriate letter on the purchase order.

See terms and conditions for contrasting fabric upcharges.

- A) One fabric or leather for seat.  
yardage: 6.5 yds. leather: 106.0 sq. ft.
- B) One fabric or leather for back.  
yardage: 5.0 yds. leather: 81.0 sq. ft.
- C) One fabric or leather for back cushion.  
yardage: 3.5 yds. leather: 57.0 sq. ft.

When ordering multi-item configurations, please provide the total COM yardage from the same dye lot in a continuous roll(s).  
\*All COM/COL fabrics must be preapproved by Bernhardt Design prior to application. SCS Indoor Advantage™ Gold certified.  
See terms and conditions for instructions for tagging COM and additional environmental information.

**alloro 4F27SR**

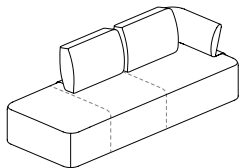

Seat Height	Arm Height	W		D		H		Fabric	Leather	Weight	Cubes/Qty	
17½"	11"	86"	34"	27¼"				15.0 yds.	244.0'	257 lbs.	77.86'/1	
445 mm	280 mm	2185 mm	864 mm	690 mm				14.0 m	23.0 sqm	116.6 kg	2.2 cu	
COM	COL	1	2	3	4	5	6	7	8	9	10	11

Three-Seat Freestanding.  
Right Arm Facing Open Module.  
Straight Front.  
Fully Upholstered.  
Two Back Cushions.

Inside Seat Width: 78¾". Inside Seat Depth: 21½".

When using a combination of fabrics or leathers, the following yardage must be used and upcharges apply. Specify the fabric or leather application by designating the appropriate letter on the purchase order.

See terms and conditions for contrasting fabric upcharges.

- A) One fabric or leather for seat.  
yardage: 6.5 yds. leather: 106.0 sq. ft.
- B) One fabric or leather for back.  
yardage: 5.0 yds. leather: 81.0 sq. ft.
- C) One fabric or leather for back cushion.  
yardage: 3.5 yds. leather: 57.0 sq. ft.

When ordering multi-item configurations, please provide the total COM yardage from the same dye lot in a continuous roll(s).  
\*All COM/COL fabrics must be preapproved by Bernhardt Design prior to application. SCS Indoor Advantage™ Gold certified.  
See terms and conditions for instructions for tagging COM and additional environmental information.

freestanding modules

**alloro 4F17FL**

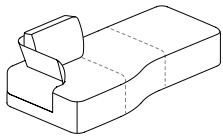

Seat Height	Arm Height	W		D		H		Fabric	Leather	Weight	Cubes/Qty	
17½"	11"	92¾"		40⅝"		27¼"		12.8 yds.	207.0'	295 lbs.	89.84/1	
445 mm	280 mm	2356 mm		1026 mm		690 mm		12.0 m	19.3 sqm	133.8 kg	2.5 cu	
COM	COL	1	2	3	4	5	6	7	8	9	10	11

Three-Seat Freestanding.  
Left Arm Facing Open Module.  
Left Side Flared Front.  
Fully Upholstered.  
One Back Cushion.

Inside Seat Width: 78¾". Inside Seat Depth: 27¾".

When using a combination of fabrics or leathers, the following yardage must be used and upcharges apply. Specify the fabric or leather application by designating the appropriate letter on the purchase order.

See terms and conditions for contrasting fabric upcharges.

- A) One fabric or leather for seat.  
yardage: 7.0 yds. leather: 114.0 sq. ft.
- B) One fabric or leather for back.  
yardage: 3.5 yds. leather: 57.0 sq. ft.
- C) One fabric or leather for back cushion.  
yardage: 2.25 yds. leather: 36.0 sq. ft.

When ordering multi-item configurations, please provide the total COM yardage from the same dye lot in a continuous roll(s).  
\*All COM/COL fabrics must be preapproved by Bernhardt Design prior to application. SCS Indoor Advantage™ Gold certified.  
See terms and conditions for instructions for tagging COM and additional environmental information.

**alloro 4F17FR**

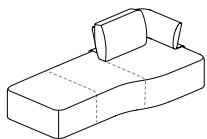

Seat Height	Arm Height	W		D		H		Fabric	Leather	Weight	Cubes/Qty	
17½"	11"	92¾"		40⅝"		27¼"		12.8 yds.	207.0'	295 lbs.	89.84/1	
445 mm	280 mm	2356 mm		1026 mm		690 mm		12.0 m	19.3 sqm	133.8 kg	2.5 cu	
COM	COL	1	2	3	4	5	6	7	8	9	10	11

Three-Seat Freestanding.  
Right Arm Facing Open Module.  
Right Side Flared Front.  
Fully Upholstered.  
One Back Cushion.

Inside Seat Width: 78¾". Inside Seat Depth: 27¾".

When using a combination of fabrics or leathers, the following yardage must be used and upcharges apply. Specify the fabric or leather application by designating the appropriate letter on the purchase order.

See terms and conditions for contrasting fabric upcharges.

- A) One fabric or leather for seat.  
yardage: 7.0 yds. leather: 114.0 sq. ft.
- B) One fabric or leather for back.  
yardage: 3.5 yds. leather: 57.0 sq. ft.
- C) One fabric or leather for back cushion.  
yardage: 2.25 yds. leather: 36.0 sq. ft.

When ordering multi-item configurations, please provide the total COM yardage from the same dye lot in a continuous roll(s).  
\*All COM/COL fabrics must be preapproved by Bernhardt Design prior to application. SCS Indoor Advantage™ Gold certified.  
See terms and conditions for instructions for tagging COM and additional environmental information.



freestanding modules

**alloro 4F27FL**

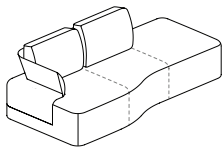

Seat Height	Arm Height	W		D		H		Fabric	Leather	Weight	Cubes/Qty	
17½"	11"	92¾"		40⅝"		27¼"		16.3 yds.	260.0'	295 lbs.	89.84/1	
445 mm	280 mm	2356 mm		1026 mm		690 mm		15.0 m	24.2 sqm	133.8 kg	2.5 cu	
COM	COL	1	2	3	4	5	6	7	8	9	10	11

Three-Seat Freestanding.  
Left Arm Facing Open Module.  
Left Side Flared Front.  
Fully Upholstered.  
Two Back Cushions.

Inside Seat Width: 78¾". Inside Seat Depth: 27¾".

When using a combination of fabrics or leathers, the following yardage must be used and upcharges apply. Specify the fabric or leather application by designating the appropriate letter on the purchase order.

See terms and conditions for contrasting fabric upcharges.

- A) One fabric or leather for seat.  
yardage: 7.25 yds. leather: 118.0 sq. ft.
- B) One fabric or leather for back.  
yardage: 5.5 yds. leather: 85.0 sq. ft.
- C) One fabric or leather for back cushion.  
yardage: 3.5 yds. leather: 57.0 sq. ft.

When ordering multi-item configurations, please provide the total COM yardage from the same dye lot in a continuous roll(s).  
\*All COM/COL fabrics must be preapproved by Bernhardt Design prior to application. SCS Indoor Advantage™ Gold certified.  
See terms and conditions for instructions for tagging COM and additional environmental information.

**alloro 4F27FR**

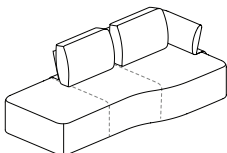

Seat Height	Arm Height	W		D		H		Fabric	Leather	Weight	Cubes/Qty	
17½"	11"	92¾"		40⅝"		27¼"		16.3 yds.	260.0'	295 lb.s	89.84/1	
445 mm	280 mm	2356 mm		1026 mm		690 mm		15.0 m	24.2 sqm	133.8 kg	2.5 cu	
COM	COL	1	2	3	4	5	6	7	8	9	10	11

Three-Seat Freestanding.  
Right Arm Facing Open Module.  
Right Side Flared Front.  
Fully Upholstered.  
Two Back Cushions.

Inside Seat Width: 78¾". Inside Seat Depth: 27¾".

When using a combination of fabrics or leathers, the following yardage must be used and upcharges apply. Specify the fabric or leather application by designating the appropriate letter on the purchase order.

See terms and conditions for contrasting fabric upcharges.

- A) One fabric or leather for seat.  
yardage: 7.25 yds. leather: 118.0 sq. ft.
- B) One fabric or leather for back.  
yardage: 5.5 yds. leather: 85.0 sq. ft.
- C) One fabric or leather for back cushion.  
yardage: 3.5 yds. leather: 57.0 sq. ft.

When ordering multi-item configurations, please provide the total COM yardage from the same dye lot in a continuous roll(s).  
\*All COM/COL fabrics must be preapproved by Bernhardt Design prior to application. SCS Indoor Advantage™ Gold certified.  
See terms and conditions for instructions for tagging COM and additional environmental information.

corner connecting modules

**alloro 4C15SL**

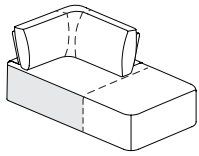

Seat Height	Arm Height	W		D		H	Fabric	Leather	Weight	Cubes/Qty		
17½"	11"	61¼"		34"		27¼"	11.5 yds.	187.0'	208 lbs.	56.06'/1		
445 mm	280 mm	1556 mm		864 mm		690 mm	11.0 m	17.4 sqm	94.4 kg	1.6 cu		
COM	COL	1	2	3	4	5	6	7	8	9	10	11

Two-seat Corner Connector.  
Left Arm Facing Module.  
Straight Front.  
Fully Upholstered.  
One Back Cushion.  
Ganging Brackets Included.

Inside Seat Width: 52½". Inside Seat Depth: 21½".

When using a combination of fabrics or leathers, the following yardage must be used and upcharges apply. Specify the fabric or leather application by designating the appropriate letter on the purchase order.

See terms and conditions for contrasting fabric upcharges.

- A) One fabric or leather for seat.  
yardage: 4.5 yds. leather: 73.0 sq. ft.
- B) One fabric or leather for back.  
yardage: 3.5 yds. leather: 57.0 sq. ft.
- C) One fabric or leather for back cushion.  
yardage: 3.5 yds. leather: 57.0 sq. ft.

When ordering multi-item configurations, please provide the total COM yardage from the same dye lot in a continuous roll(s).  
\*All COM/COL fabrics must be preapproved by Bernhardt Design prior to application. SCS Indoor Advantage™ Gold certified.  
See terms and conditions for instructions for tagging COM and additional environmental information. Freestanding option not available.

**alloro 4C15SR**

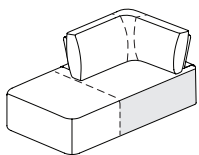

Seat Height	Arm Height	W		D		H	Fabric	Leather	Weight	Cubes/Qty		
17½"	11"	61¼"		34"		27¼"	11.5 yds.	187.0'	208 lbs.	56.06'/1		
445 mm	280 mm	1556 mm		864 mm		690 mm	11.0 m	17.4 sqm	94.4 kg	1.6 cu		
COM	COL	1	2	3	4	5	6	7	8	9	10	11

Two-seat Corner Connector.  
Right Arm Facing.  
Straight Front.  
Fully Upholstered.  
One Back Cushion.  
Ganging Brackets Included.

Inside Seat Width: 52½". Inside Seat Depth: 21½".

When using a combination of fabrics or leathers, the following yardage must be used and upcharges apply. Specify the fabric or leather application by designating the appropriate letter on the purchase order.

See terms and conditions for contrasting fabric upcharges.

- A) One fabric or leather for seat.  
yardage: 4.5 yds. leather: 73.0 sq. ft.
- B) One fabric or leather for back.  
yardage: 3.5 yds. leather: 57.0 sq. ft.
- C) One fabric or leather for back cushion.  
yardage: 3.5 yds. leather: 57.0 sq. ft.

When ordering multi-item configurations, please provide the total COM yardage from the same dye lot in a continuous roll(s).  
\*All COM/COL fabrics must be preapproved by Bernhardt Design prior to application. SCS Indoor Advantage™ Gold certified.  
See terms and conditions for instructions for tagging COM and additional environmental information. Freestanding option not available.

corner connecting modules

**alloro 4C17SL**

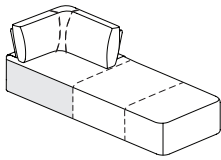

Seat Height	Arm Height	W		D		H		Fabric	Leather	Weight	Cubes/Qty	
17½"	11"	86¾"		34"		27¼"		13.5 yds.	224.0'	290 lbs.	77.86'/1	
445 mm	280 mm	2001 mm		864 mm		690 mm		12.4 m	20.9 sqm	132 kg	2.2 cu	
COM	COL	1	2	3	4	5	6	7	8	9	10	11

Three-seat Corner Connector.  
Left Arm Facing Open Module.  
Straight Front.  
Fully Upholstered.  
One Back Cushion.  
Ganging Brackets Included.

Inside Seat Width: 78¾". Inside Seat Depth: 21½".

When using a combination of fabrics or leathers, the following yardage must be used and upcharges apply. Specify the fabric or leather application by designating the appropriate letter on the purchase order.

See terms and conditions for contrasting fabric upcharges.

- A) One fabric or leather for seat.  
yardage: 6.5 yds. leather: 110.0 sq. ft.
- B) One fabric or leather for back.  
yardage: 3.5 yds. leather: 57.0 sq. ft.
- C) One fabric or leather for back cushion.  
yardage: 3.5 yds. leather: 57.0 sq. ft.

When ordering multi-item configurations, please provide the total COM yardage from the same dye lot in a continuous roll(s).  
\*All COM/COL fabrics must be preapproved by Bernhardt Design prior to application. SCS Indoor Advantage™ Gold certified.  
See terms and conditions for instructions for tagging COM and additional environmental information. Freestanding option not available.

**alloro 4C17SR**

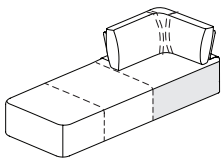

Seat Height	Arm Height	W		D		H		Fabric	Leather	Weight	Cubes/Qty	
17½"	11"	86¾"		34"		27¼"		13.5 yds.	224.0'	290 lbs.	77.86'/1	
445 mm	280 mm	2001 mm		864 mm		690 mm		12.4 m	20.9 sqm	132 kg	2.2 cu	
COM	COL	1	2	3	4	5	6	7	8	9	10	11

Three-seat Corner Connector.  
Right Arm Facing Open Module.  
Straight Front.  
Fully Upholstered.  
One Back Cushion.  
Ganging Brackets Included.

Inside Seat Width: 78¾". Inside Seat Depth: 21½".

When using a combination of fabrics or leathers, the following yardage must be used and upcharges apply. Specify the fabric or leather application by designating the appropriate letter on the purchase order.

See terms and conditions for contrasting fabric upcharges.

- A) One fabric or leather for seat.  
yardage: 6.5 yds. leather: 110.0 sq. ft.
- B) One fabric or leather for back.  
yardage: 3.5 yds. leather: 57.0 sq. ft.
- C) One fabric or leather for back cushion.  
yardage: 3.5 yds. leather: 57.0 sq. ft.

When ordering multi-item configurations, please provide the total COM yardage from the same dye lot in a continuous roll(s).  
\*All COM/COL fabrics must be preapproved by Bernhardt Design prior to application. SCS Indoor Advantage™ Gold certified.  
See terms and conditions for instructions for tagging COM and additional environmental information. Freestanding option not available.

corner connecting modules

**alloro 4C27SL**

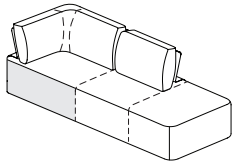

Seat Height	Arm Height	W		D		H		Fabric	Leather	Weight	Cubes/Qty	
17½"	11"	86¾"		34"		27¼"		16.5 yds.	272.0'	290 lbs.	77.86'/1	
445 mm	280 mm	2001 mm		864 mm		690 mm		15.1 m	25.3 sqm	132 kg	2.2 cu	
COM	COL	1	2	3	4	5	6	7	8	9	10	11

Three-seat Corner Connector.  
Left Arm Facing Open Module.  
Straight Front.  
Fully Upholstered.  
Two Back Cushions.  
Ganging Brackets Included.

Inside Seat Width: 78¾". Inside Seat Depth: 21½".

When using a combination of fabrics or leathers, the following yardage must be used and upcharges apply. Specify the fabric or leather application by designating the appropriate letter on the purchase order.

See terms and conditions for contrasting fabric upcharges.

- A) One fabric or leather for seat.  
yardage: 6.5 yds. leather: 110.0 sq. ft.
- B) One fabric or leather for back.  
yardage: 5.0 yds. leather: 81.0 sq. ft.
- C) One fabric or leather for back cushion.  
yardage: 5.0 yds. leather: 81.0 sq. ft.

When ordering multi-item configurations, please provide the total COM yardage from the same dye lot in a continuous roll(s).  
\*All COM/COL fabrics must be preapproved by Bernhardt Design prior to application. SCS Indoor Advantage™ Gold certified.  
See terms and conditions for instructions for tagging COM and additional environmental information. Freestanding option not available.

**alloro 4C27SR**

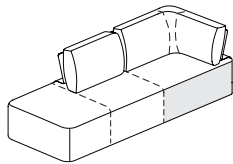

Seat Height	Arm Height	W		D		H		Fabric	Leather	Weight	Cubes/Qty	
17½"	11"	86¾"		34"		27¼"		16.5 yds.	272.0'	290 lbs.	77.86'/1	
445 mm	280 mm	2001 mm		864 mm		690 mm		15.1 m	25.3 sqm	132 kg	2.2 cu	
COM	COL	1	2	3	4	5	6	7	8	9	10	11

Three-seat Corner Connector.  
Right Arm Facing Open Module.  
Straight Front.  
Fully Upholstered.  
Two Back Cushions.  
Ganging Brackets Included.

Inside Seat Width: 78¾". Inside Seat Depth: 21½".

When using a combination of fabrics or leathers, the following yardage must be used and upcharges apply. Specify the fabric or leather application by designating the appropriate letter on the purchase order.

See terms and conditions for contrasting fabric upcharges.

- A) One fabric or leather for seat.  
yardage: 6.5 yds. leather: 110.0 sq. ft.
- B) One fabric or leather for back.  
yardage: 5.0 yds. leather: 81.0 sq. ft.
- C) One fabric or leather for back cushion.  
yardage: 5.0 yds. leather: 81.0 sq. ft.

When ordering multi-item configurations, please provide the total COM yardage from the same dye lot in a continuous roll(s).  
\*All COM/COL fabrics must be preapproved by Bernhardt Design prior to application. SCS Indoor Advantage™ Gold certified.  
See terms and conditions for instructions for tagging COM and additional environmental information. Freestanding option not available.

end connecting modules

**alloro 4D25SL**

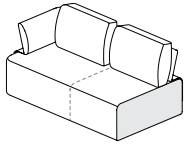

Seat Height	Arm Height	W	D	H	Fabric	Leather	Weight	Cubes/Qty				
17½"	11"	61¼"	34"	27¼"	13.0 yds.	211.0'	208 lbs.	56.06'/1				
445 mm	280 mm	1556 mm	864 mm	690 mm	12.0 m	20.0 sqm	94.4 kg	1.6 cu				
COM	COL	1	2	3	4	5	6	7	8	9	10	11

Two-seat End Connector.  
Left Arm Facing Module.  
Straight Front.  
Fully Upholstered.  
Two Back Cushions.  
Ganging Brackets Included.

Inside Seat Width: 52½". Inside Seat Depth: 21½".

When using a combination of fabrics or leathers, the following yardage must be used and upcharges apply. Specify the fabric or leather application by designating the appropriate letter on the purchase order.

See terms and conditions for contrasting fabric upcharges.

- A) One fabric or leather for seat.  
yardage: 4.5 yds. leather: 73.0 sq. ft.
- B) One fabric or leather for back.  
yardage: 5.0 yds. leather: 81.0 sq. ft.
- C) One fabric or leather for back cushion.  
yardage: 3.5 yds. leather: 57.0 sq. ft.

When ordering multi-item configurations, please provide the total COM yardage from the same dye lot in a continuous roll(s).  
\*All COM/COL fabrics must be preapproved by Bernhardt Design prior to application. SCS Indoor Advantage™ Gold certified.  
See terms and conditions for instructions for tagging COM and additional environmental information. Freestanding option not available.

**alloro 4D25SR**

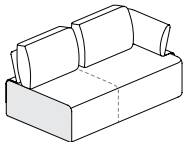

Seat Height	Arm Height	W	D	H	Fabric	Leather	Weight	Cubes/Qty				
17½"	11"	61¼"	34"	27¼"	13 yds.	211.0'	208 lbs.	56.06'/1				
445 mm	280 mm	1556 mm	864 mm	690 mm	12.0 m	20.0 sqm	94.4 kg	1.6 cu				
COM	COL	1	2	3	4	5	6	7	8	9	10	11

Two-seat End Connector.  
Right Arm Facing Module.  
Straight Front.  
Fully Upholstered.  
Two Back Cushions.  
Ganging Brackets Included.

Inside Seat Width: 52½". Inside Seat Depth: 21½".

When using a combination of fabrics or leathers, the following yardage must be used and upcharges apply. Specify the fabric or leather application by designating the appropriate letter on the purchase order.

See terms and conditions for contrasting fabric upcharges.

- A) One fabric or leather for seat.  
yardage: 4,5 yds. leather: 73.0 sq. ft.
- B) One fabric or leather for back.  
yardage: 5.0 yds. leather: 81.0 sq. ft.
- C) One fabric or leather for back cushion.  
yardage: 3.5 yds. leather: 57.0 sq. ft.

When ordering multi-item configurations, please provide the total COM yardage from the same dye lot in a continuous roll(s).  
\*All COM/COL fabrics must be preapproved by Bernhardt Design prior to application. SCS Indoor Advantage™ Gold certified.  
See terms and conditions for instructions for tagging COM and additional environmental information. Freestanding option not available.

end connecting modules

**alloro 4D37SL**

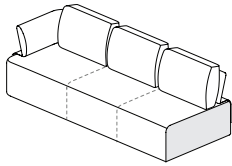

Seat Height	Arm Height	W		D		H		Fabric	Leather	Weight	Cubes/Qty	
17½"	11"	86¾"	34"	27¼"				18.0 yds.	301.0'	290 lbs.	77.86'/1	
445 mm	280 mm	2001 mm	864 mm	690 mm				16.5 m	28.0 sqm	132 kg	2.2 cu	
COM	COL	1	2	3	4	5	6	7	8	9	10	11

Three-seat End Connector.  
Left Arm Facing Module.  
Straight Front.  
Fully Upholstered.  
Three Back Cushions.  
Ganging Brackets Included.

Inside Seat Width: 78¾". Inside Seat Depth: 21½".

When using a combination of fabrics or leathers, the following yardage must be used and upcharges apply. Specify the fabric or leather application by designating the appropriate letter on the purchase order.

See terms and conditions for contrasting fabric upcharges.

- A) One fabric or leather for seat.  
yardage: 6.5 yds. leather: 110.0 sq. ft.
- B) One fabric or leather for back.  
yardage: 6.5 yds. leather: 110.0 sq. ft.
- C) One fabric or leather for back cushion.  
yardage: 5.0 yds. leather: 81.0 sq. ft.

When ordering multi-item configurations, please provide the total COM yardage from the same dye lot in a continuous roll(s).  
\*All COM/COL fabrics must be preapproved by Bernhardt Design prior to application. SCS Indoor Advantage™ Gold certified.  
See terms and conditions for instructions for tagging COM and additional environmental information. Freestanding option not available.

**alloro 4D37SR**

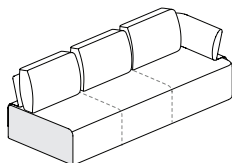

Seat Height	Arm Height	W		D		H		Fabric	Leather	Weight	Cubes/Qty	
17½"	11"	86¾"	34"	27¼"				18.0 yds.	301.0'	290 lbs.	77.86'/1	
445 mm	280 mm	2001 mm	864 mm	690 mm				16.5 m	28.0 sqm	132 kg	2.2 cu	
COM	COL	1	2	3	4	5	6	7	8	9	10	11

Three-seat End Connector.  
Right Arm Facing Module.  
Straight Front.  
Fully Upholstered.  
Three Back Cushions.  
Ganging Brackets Included.

Inside Seat Width: 78¾". Inside Seat Depth: 21½".

When using a combination of fabrics or leathers, the following yardage must be used and upcharges apply. Specify the fabric or leather application by designating the appropriate letter on the purchase order.

See terms and conditions for contrasting fabric upcharges.

- A) One fabric or leather for seat.  
yardage: 6.5 yds. leather: 110.0 sq. ft.
- B) One fabric or leather for back.  
yardage: 6.5 yds. leather: 110.0 sq. ft.
- C) One fabric or leather for back cushion.  
yardage: 5.0 yds. leather: 81.0 sq. ft.

When ordering multi-item configurations, please provide the total COM yardage from the same dye lot in a continuous roll(s).  
\*All COM/COL fabrics must be preapproved by Bernhardt Design prior to application. SCS Indoor Advantage™ Gold certified.  
See terms and conditions for instructions for tagging COM and additional environmental information. Freestanding option not available.

end connecting modules

**alloro 4D25FL**

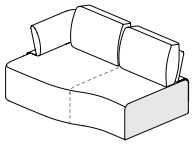

Seat Height	Arm Height	W		D		H		Fabric	Leather	Weight	Cubes/Qty	
17½"	11"	61¼"		40¾"		27¼"		13.5 yds.	219.0'	218 lbs.	64.69'/1	
445 mm	280 mm	1556 mm		1026 mm		690 mm		12.4 m	20.4 sqm	99.0 kg	1.9 cu	
COM	COL	1	2	3	4	5	6	7	8	9	10	11

Two-seat End Connector.  
Left Arm Facing Module.  
Left Side Flared Front.  
Fully Upholstered.  
Two Back Cushions.  
Ganging Brackets Included.

Inside Seat Width: 53½". Inside Seat Depth: 21½".

When using a combination of fabrics or leathers, the following yardage must be used and upcharges apply. Specify the fabric or leather application by designating the appropriate letter on the purchase order.

See terms and conditions for contrasting fabric upcharges.

- A) One fabric or leather for seat.  
yardage: 5.0 yds. leather: 81.0 sq. ft.
- B) One fabric or leather for back.  
yardage: 5.0 yds. leather: 81.0 sq. ft.
- C) One fabric or leather for back cushion.  
yardage: 3.5 yds. leather: 57.0 sq. ft.

When ordering multi-item configurations, please provide the total COM yardage from the same dye lot in a continuous roll(s).  
\*All COM/COL fabrics must be preapproved by Bernhardt Design prior to application. SCS Indoor Advantage™ Gold certified.  
See terms and conditions for instructions for tagging COM and additional environmental information. Freestanding option not available.

**alloro 4D25FR**

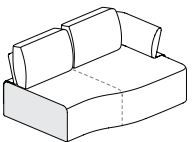

Seat Height	Arm Height	W		D		H		Fabric	Leather	Weight	Cubes/Qty	
17½"	11"	61¼"		40¾"		27¼"		13.5 yds.	219.0'	218 lbs.	64.69'/1	
445 mm	280 mm	1556 mm		1026 mm		690 mm		12.4m	20.4 sqm	99.0 kg	1.9 cu	
COM	COL	1	2	3	4	5	6	7	8	9	10	11

Two-seat End Connector.  
Right Arm Facing Module.  
Right Side Flared Front.  
Fully Upholstered.  
Two Back Cushions.  
Ganging Brackets Included.

Inside Seat Width: 53½". Inside Seat Depth: 21½".

When using a combination of fabrics or leathers, the following yardage must be used and upcharges apply. Specify the fabric or leather application by designating the appropriate letter on the purchase order.

See terms and conditions for contrasting fabric upcharges.

- A) One fabric or leather for seat.  
yardage: 5.0 yds. leather: 81.0 sq. ft.
- B) One fabric or leather for back.  
yardage: 5.0 yds. leather: 81.0 sq. ft.
- C) One fabric or leather for back cushion.  
yardage: 3.5 yds. leather: 57.0 sq. ft.

When ordering multi-item configurations, please provide the total COM yardage from the same dye lot in a continuous roll(s).  
\*All COM/COL fabrics must be preapproved by Bernhardt Design prior to application. SCS Indoor Advantage™ Gold certified.  
See terms and conditions for instructions for tagging COM and additional environmental information. Freestanding option not available.

end connecting modules

**alloro 4D37FL**

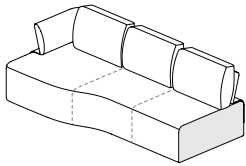

Seat Height	Arm Height	W		D		H		Fabric	Leather	Weight	Cubes/Qty	
17½"	11"	86¾"		40¾"		27¼"		19.3 yds.	317.0'	303 lbs.	89.84'/1	
445 mm	280 mm	2001 mm		1026 mm		690 mm		18.0 m	29.6 sqm	137.5 kg	2.6 cu	
COM	COL	1	2	3	4	5	6	7	8	9	10	11

Three-seat End Connector.  
Left Arm Facing Module.  
Left Side Flared Front.  
Fully Upholstered.  
Three Back Cushions.  
Ganging Brackets Included.

Inside Seat Width: 78¾". Inside Seat Depth: 21½".

When using a combination of fabrics or leathers, the following yardage must be used and upcharges apply. Specify the fabric or leather application by designating the appropriate letter on the purchase order.

See terms and conditions for contrasting fabric upcharges.

- A) One fabric or leather for seat.  
yardage: 7.75 yds. leather: 126.0 sq. ft.
- B) One fabric or leather for back.  
yardage: 6.5 yds. leather: 110.0 sq. ft.
- C) One fabric or leather for back cushion.  
yardage: 5.0 yds. leather: 81.0 sq. ft.

When ordering multi-item configurations, please provide the total COM yardage from the same dye lot in a continuous roll(s).  
\*All COM/COL fabrics must be preapproved by Bernhardt Design prior to application. SCS Indoor Advantage™ Gold certified.  
See terms and conditions for instructions for tagging COM and additional environmental information. Freestanding option not available.

**alloro 4D37FR**

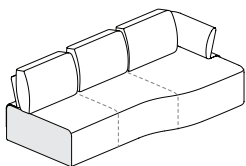

Seat Height	Arm Height	W		D		H		Fabric	Leather	Weight	Cubes/Qty	
17½"	11"	86¾"		40¾"		27¼"		19.3 yds.	317.0'	303 lbs.	89.84'/1	
445 mm	280 mm	2001 mm		1026 mm		690 mm		18.0 m	29.6 sqm	137.5 kg	2.6 cu	
COM	COL	1	2	3	4	5	6	7	8	9	10	11

Three-seat End Connector.  
Right Arm Facing Module.  
Right Side Flared Front.  
Fully Upholstered.  
Three Back Cushions.  
Ganging Brackets Included.

Inside Seat Width: 78¾". Inside Seat Depth: 21½".

When using a combination of fabrics or leathers, the following yardage must be used and upcharges apply. Specify the fabric or leather application by designating the appropriate letter on the purchase order.

See terms and conditions for contrasting fabric upcharges.

- A) One fabric or leather for seat.  
yardage: 7.75 yds. leather: 126.0 sq. ft.
- B) One fabric or leather for back.  
yardage: 6.5 yds. leather: 110.0 sq. ft.
- C) One fabric or leather for back cushion  
yardage: 5.0 yds. leather: 81.0 sq. ft.

When ordering multi-item configurations, please provide the total COM yardage from the same dye lot in a continuous roll(s).  
\*All COM/COL fabrics must be preapproved by Bernhardt Design prior to application. SCS Indoor Advantage™ Gold certified.  
See terms and conditions for instructions for tagging COM and additional environmental information. Freestanding option not available.



**both sides connecting units**

**alloro 4B25SL**

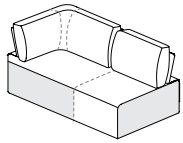

Seat Height	Arm Height	W	D	H	Fabric	Leather	Weight	Cubes/Qty				
17½"	11"	61¼"	34"	27¼"	14.5 yds.	235.0'	208 lbs.	56.06'/1				
445 mm	280 mm	1556 mm	864 mm	690 mm	13.3 m	22.0 sqm	94.4 kg	1.6 cu				
COM	COL	1	2	3	4	5	6	7	8	9	10	11

Two-seat Connector.  
Left Arm Facing Module.  
Straight Front.  
Fully Upholstered.  
Two Back Cushions.  
Ganging Brackets Included.

Inside Seat Width: 52½". Inside Seat Depth: 21½".

When using a combination of fabrics or leathers, the following yardage must be used and upcharges apply. Specify the fabric or leather application by designating the appropriate letter on the purchase order.

See terms and conditions for contrasting fabric upcharges.

- A) One fabric or leather for seat.  
yardage: 4.5 yds. leather: 73.0 sq. ft.
- B) One fabric or leather for back.  
yardage: 5.0 yds. leather: 81.0 sq. ft.
- C) One fabric or leather for back cushion.  
yardage: 5.0 yds. leather: 81.0 sq. ft.

When ordering multi-item configurations, please provide the total COM yardage from the same dye lot in a continuous roll(s).  
\*All COM/COL fabrics must be preapproved by Bernhardt Design prior to application. SCS Indoor Advantage™ Gold certified.  
See terms and conditions for instructions for tagging COM and additional environmental information. Freestanding option not available.

**alloro 4B25SR**

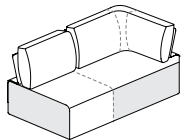

Seat Height	Arm Height	W	D	H	Fabric	Leather	Weight	Cubes/Qty				
17½"	11"	61¼"	34"	27¼"	14.5 yds.	235.0'	208 lbs.	56.06'/1				
445 mm	280 mm	1556 mm	864 mm	690 mm	13.3 m	22.0 sqm	94.4 kg	1.6 cu				
COM	COL	1	2	3	4	5	6	7	8	9	10	11

Two-seat Connector.  
Right Arm Facing Module.  
Straight Front.  
Fully Upholstered.  
Two Back Cushions.  
Ganging Brackets Included.

Inside Seat Width: 52½". Inside Seat Depth: 21½".

When using a combination of fabrics or leathers, the following yardage must be used and upcharges apply. Specify the fabric or leather application by designating the appropriate letter on the purchase order.

See terms and conditions for contrasting fabric upcharges.

- A) One fabric or leather for seat.  
yardage: 4.5 yds. leather: 73.0 sq. ft.
- B) One fabric or leather for back.  
yardage: 5.0 yds. leather: 81.0 sq. ft.
- C) One fabric or leather for back cushion.  
yardage: 5.0 yds. leather: 81.0 sq. ft.

When ordering multi-item configurations, please provide the total COM yardage from the same dye lot in a continuous roll(s).  
\*All COM/COL fabrics must be preapproved by Bernhardt Design prior to application. SCS Indoor Advantage™ Gold certified.  
See terms and conditions for instructions for tagging COM and additional environmental information. Freestanding option not available.

**both sides connecting units**

**alloro 4B37SL**

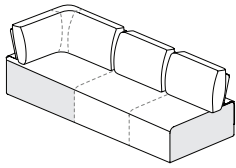

Seat Height	Arm Height	W	D	H	Fabric	Leather	Weight		
17½"	11"	86¾"	34"	27¼"	20.0 yds.	334.0'	290 lbs.	77.86'/1	
445 mm	280 mm	2001 mm	864 mm	690 mm	18.3 m	31.1 sqm	132 kg	2.2 cu	

COM	COL	1	2	3	4	5	6	7	8	9	10	11

Three-seat Connector.  
Left Arm Facing Module.  
Straight Front.  
Fully Upholstered.  
Three Back Cushions.  
Ganging Brackets Included.

Inside Seat Width: 78¾". Inside Seat Depth: 21½".

When using a combination of fabrics or leathers, the following yardage must be used and upcharges apply. Specify the fabric or leather application by designating the appropriate letter on the purchase order.

See terms and conditions for contrasting fabric upcharges.

- A) One fabric or leather for seat.  
yardage: 6.5 yds. leather: 110.0 sq. ft.
- B) One fabric or leather for back.  
yardage: 7.0 yds. leather: 114.0 sq. ft.
- C) One fabric or leather for back cushion.  
yardage: 6.5 yds. leather: 110.0 sq. ft.

When ordering multi-item configurations, please provide the total COM yardage from the same dye lot in a continuous roll(s).  
\*All COM/COL fabrics must be preapproved by Bernhardt Design prior to application. SCS Indoor Advantage™ Gold certified.  
See terms and conditions for instructions for tagging COM and additional environmental information. Freestanding option not available.

**alloro 4B37SR**

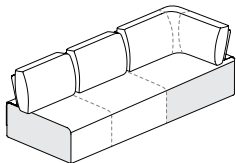

Seat Height	Arm Height	W	D	H	Fabric	Leather	Weight		
17½"	11"	86¾"	34"	27¼"	20.0 yds.	334.0'	290 lbs.	77.86'/1	
445 mm	280 mm	2001 mm	864 mm	690 mm	18.3 m	31.1 sqm	132 kg	2.2 cu	

COM	COL	1	2	3	4	5	6	7	8	9	10	11

Three-seat Connector.  
Right Arm Facing Module.  
Straight Front.  
Fully Upholstered.  
Three Back Cushions.  
Ganging Brackets Included.

Inside Seat Width: 78¾". Inside Seat Depth: 21½".

When using a combination of fabrics or leathers, the following yardage must be used and upcharges apply. Specify the fabric or leather application by designating the appropriate letter on the purchase order.

See terms and conditions for contrasting fabric upcharges.

- A) One fabric or leather for seat.  
yardage: 6.5 yds. leather: 110.0 sq. ft.
- B) One fabric or leather for back.  
yardage: 7.0 yds. leather: 114.0 sq. ft.
- C) One fabric or leather for back cushion.  
yardage: 6.5 yds. leather: 110.0 sq. ft.

When ordering multi-item configurations, please provide the total COM yardage from the same dye lot in a continuous roll(s).  
\*All COM/COL fabrics must be preapproved by Bernhardt Design prior to application. SCS Indoor Advantage™ Gold certified.  
See terms and conditions for instructions for tagging COM and additional environmental information. Freestanding option not available.

**both sides connecting units**

**alloro 4B11SX**

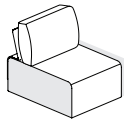

Seat Height	Arm Height	W	D	H	Fabric	Leather	Weight	Cubes/Qty				
17½"	11"	26¼"	34"	27¼"	6.5 yds.	103.0'	78 lbs.	24.92/1				
445 mm	280 mm	667 mm	864 mm	690 mm	6.0 m	10.0 sqm	35.4 kg	.71 cu				
COM	COL	1	2	3	4	5	6	7	8	9	10	11

Single Seat Connector.  
Straight Front Module.  
Fully Upholstered.  
One Back Cushion.  
Ganging Brackets Included.

Inside Seat Width: 26¼". Inside Seat Depth: 21½".

When using a combination of fabrics or leathers, the following yardage must be used and upcharges apply. Specify the fabric or leather application by designating the appropriate letter on the purchase order.

See terms and conditions for contrasting fabric upcharges.

- A) One fabric or leather for seat.  
yardage: 2.5 yds. leather: 41.0 sq. ft.
- B) One fabric or leather for back.  
yardage: 2.0 yds. leather: 31.0 sq. ft.
- C) One fabric or leather for back cushion.  
yardage: 2.0 yds. leather: 31.0 sq. ft.

When ordering multi-item configurations, please provide the total COM yardage from the same dye lot in a continuous roll(s).  
\*All COM/COL fabrics must be preapproved by Bernhardt Design prior to application. SCS Indoor Advantage™ Gold certified.  
See terms and conditions for instructions for tagging COM and additional environmental information. Freestanding option not available.

**alloro 4B25SX**

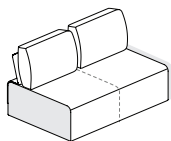

Seat Height	Arm Height	W	D	H	Fabric	Leather	Weight	Cubes/Qty				
17½"	11"	52½"	34"	27¼"	11.5 yds.	187.0'	149 lbs.	46.72/1				
445 mm	280 mm	1337 mm	864 mm	690 mm	11.0 m	17.4 sqm	67.6 kg	1.3 cu				
COM	COL	1	2	3	4	5	6	7	8	9	10	11

Two-seat Connector.  
Straight Front Module.  
Fully Upholstered.  
Two Back Cushions.  
Ganging Brackets Included.

Inside Seat Width: 52½". Inside Seat Depth: 21½".

When using a combination of fabrics or leathers, the following yardage must be used and upcharges apply. Specify the fabric or leather application by designating the appropriate letter on the purchase order.

See terms and conditions for contrasting fabric upcharges.

- A) One fabric or leather for seat.  
yardage: 4.5 yds. leather: 73.0 sq. ft.
- B) One fabric or leather for back.  
yardage: 3.5 yds. leather: 57.0 sq. ft.
- C) One fabric or leather for back cushion.  
yardage: 3.5 yds. leather: 57.0 sq. ft.

When ordering multi-item configurations, please provide the total COM yardage from the same dye lot in a continuous roll(s).  
\*All COM/COL fabrics must be preapproved by Bernhardt Design prior to application. SCS Indoor Advantage™ Gold certified.  
See terms and conditions for instructions for tagging COM and additional environmental information. Freestanding option not available.

**both sides connecting units**

**alloro 4B37SX**

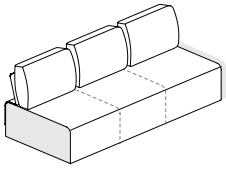

Seat Height	Arm Height	W	D	H	Fabric	Leather	Weight	Cubes/Qty				
17½"	11"	78⅞"	34"	27¼"	17.0 yds.	281.0'	217 lbs.	66.18				
445 mm	280 mm	2004 mm	864 mm	690 mm	16.0 m	26.2 sqm	98.5 kg	1.9 cu				
COM	COL	1	2	3	4	5	6	7	8	9	10	11

Three-seat Connector.  
Straight Front Module.  
Fully Upholstered.  
Three Back Cushions.  
Ganging Brackets Included.

Inside Seat Width: 78¾". Inside Seat Depth: 21½".

When using a combination of fabrics or leathers, the following yardage must be used and upcharges apply. Specify the fabric or leather application by designating the appropriate letter on the purchase order.

See terms and conditions for contrasting fabric upcharges.

- A) One fabric or leather for seat.  
yardage: 6.5 yds. leather: 110.0 sq. ft.
- B) One fabric or leather for back.  
yardage: 5.5 yds. leather: 90.0 sq. ft.
- C) One fabric or leather for back cushion.  
yardage: 5.0 yds. leather: 81.0s sq. ft.

When ordering multi-item configurations, please provide the total COM yardage from the same dye lot in a continuous roll(s).  
\*All COM/COL fabrics must be preapproved by Bernhardt Design prior to application. SCS Indoor Advantage™ Gold certified.  
See terms and conditions for instructions for tagging COM and additional environmental information. Freestanding option not available.

	Seat Height	Arm Height	W	D	H	Fabric	Leather	Weight	Cubes/Qty			
<b>4PD decorative pillow</b>	-	-	16½"	4"	16½"	1 yd.	18.0'	8 lbs.	.89/1			
	-	-	419 mm	102 mm	419 mm	.91 m	1.7 sqm	3.6 kg	.03 cu.			
COM	COL	1	2	3	4	5	6	7	8	9	10	11



½" Panel Border Pillow.

All COM/COL fabrics must be preapproved by Bernhardt Design prior to application.