

**Description**  
**Beschreibung**

Wooden sideboards available in different sizes and finishes. Base with steel legs and black finish, with the option of polished chrome finish. This collection, in addition to the door and drawer modules, includes an open module with shelf in smoked glass finish.  
Holz Sideboards in verschiedenen Größen und Ausführungen erhältlich. Gestell mit Stahlbeinen und schwarzem Finish, mit einer glänzenden Finish-Option. Diese Kollektion umfasst neben den Tür- und Schubladenmodulen ein offenes Modul mit Smoked Glass.

**Wood finish Oak**  
**Holzausführungen**  
**Eiche**



**Wood lacquer finish**  
**Holzlackausführungen**



**Wood finish Walnut**  
**Holzausführungen**  
**Nussbaum**

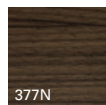

**Technical Stone 8**  
**finish**

**Technical Stone 8**  
**ausführungen**

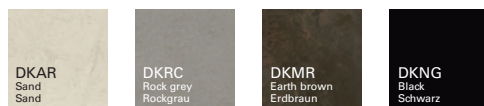

**Glass finish**

**Glasausführungen**



**M1 marble finish**

**M1 Marmor-**  
**Ausführung**



**M3 marble finish**

**M3 Marmor-**  
**Ausführung**



**Intellectual property Geistiges Eigentum**

All our collections are protected by international industrial design registries, designs patents, copyrights and intellectual Property laws. Unauthorized use of AW International Property is a criminal offence and can lead to prosecution.  
Alle unsere Kollektionen sind durch internationale Industrie-Design Registern, Design Patente, Urheberrecht und geistiges Eigentum rechtlich geschützt. Die unbefugte Nutzung des internationalen Eigentums von AW ist eine Straftat und kann zur Strafverfolgung führen.



CONFIGURATION DIAGRAM  
KONFIGURATIONSDIAGRAMM

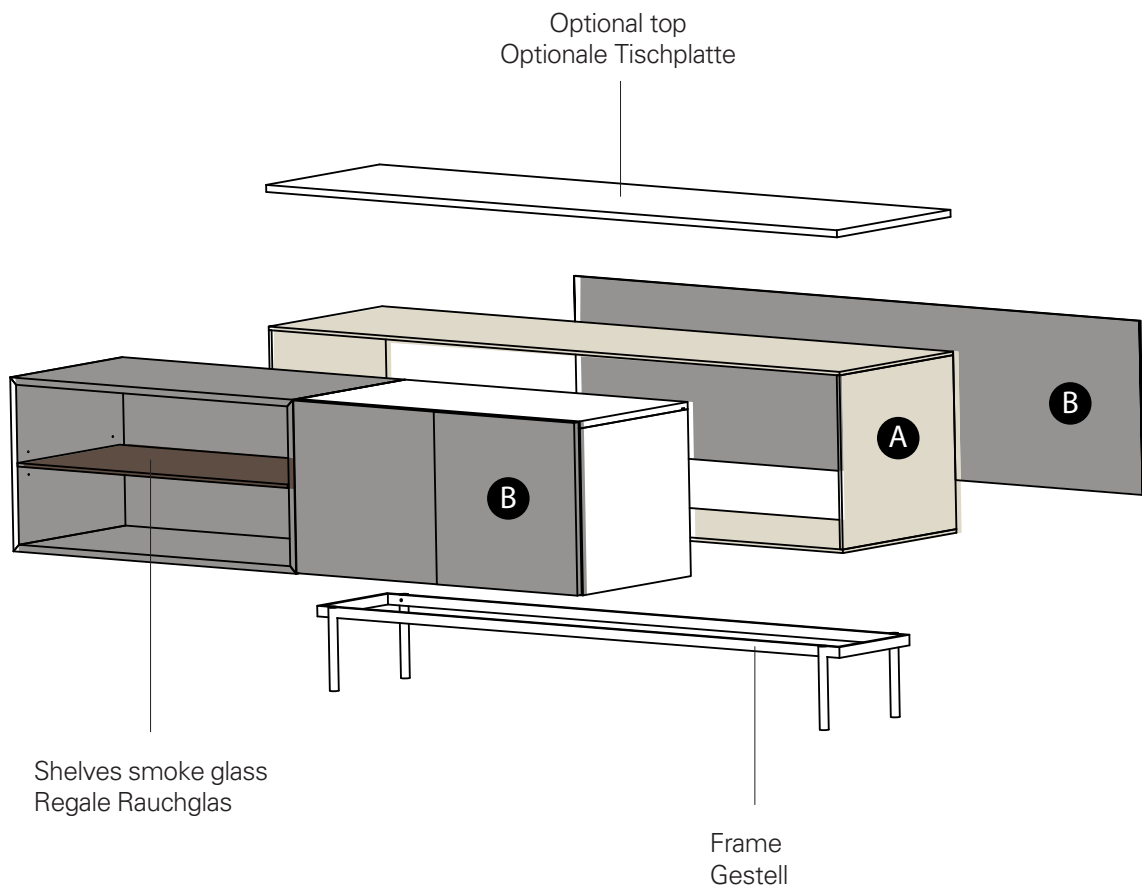

**A** Exterior material / Aussenmaterial

**B** Front and back material / Vorder- und Rückenmaterial

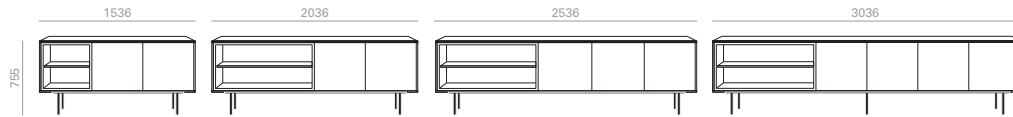

Top measures Größe der Tischplatte	Exterior material Außenmaterial			Front and back material / Vorder- und Rückenmaterial					
				Oak Eiche		Walnut Nussbaum		Lacquered Lackiert	
				Ref.		Ref.		Ref.	
1536x530x755	Oak Eiche	S600		AP04800		AP04801		AP04802	
				kg	148'9	148'9	148'9		
				3 boxes / kartons	1,09	1,09	1,09		
2036x530x755	Oak Eiche	S600		AP04836		AP04837		AP04838	
				kg	166'5	166'5	166'5		
				5 boxes / kartons	1,25	1,25	1,25		
2536x530x755	Oak Eiche	S600		AP04872		AP04873		AP04874	
				kg	181'7	181'7	181'7		
				5 boxes / kartons	1,57	1,57	1,57		
3036x530x755	Oak Eiche	S600		AP04908		AP04909		AP04910	
				kg	208'9	208'9	208'9		
				6 boxes / kartons	1,82	1,82	1,82		
1536x530x755	Walnut Nussbaum			AP04803		AP04804		AP04805	
	kg	148'9		148'9	148'9				
	3 boxes / kartons	1,09		1,09	1,09				
2036x530x755	Walnut Nussbaum			AP04839		AP04840		AP04841	
	kg	166'5		166'5	166'5				
	5 boxes / kartons	1,25		1,25	1,25				
2536x530x755	Walnut Nussbaum			AP04875		AP04876		AP04877	
	kg	181'7		181'7	181'7				
	5 boxes / kartons	1,57		1,57	1,57				
3036x530x755	Walnut Nussbaum			AP04911		AP04912		AP04913	
	kg	208'9		208'9	208'9				
	6 boxes / kartons	1,82		1,82	1,82				
1536x530x755	Lacquered Lackiert			AP04806		AP04807		AP04808	
	kg	148'9		148'9	148'9				
	3 boxes / kartons	1,09		1,09	1,09				
2036x530x755	Lacquered Lackiert			AP04842		AP04843		AP04844	
	kg	166'5		166'5	166'5				
	5 boxes / kartons	1,25		1,25	1,25				
2536x530x755	Lacquered Lackiert			AP04878		AP04879		AP04880	
	kg	181'7		181'7	181'7				
	5 boxes / kartons	1,57		1,57	1,57				
3036x530x755	Lacquered Lackiert			AP04914		AP04915		AP04916	
	kg	208'9		208'9	208'9				
	6 boxes / kartons	1,82		1,82	1,82				











Polished Chrome upcharge  
1536x530x755  
Aufpreis für Glanzverchromt

Polished Chrome upcharge  
2036x530x755  
Aufpreis für Glanzverchromt

Polished Chrome upcharge  
2536x530x755  
Aufpreis für Glanzverchromt

Polished Chrome upcharge  
3036x530x755  
Aufpreis für Glanzverchromt

Optional table tops /Optionale Tischplatten				
Top measures Grösse der Tischplatte	***Technical Stone 8	***Low Iron Glass Optisch Glas	***Marble M1 Marmor M1	Marble M3 Marmor M3
<b>1520x530x766</b>				
 kg	49.5	56.9	69.5	69.5
 m3	0.51	0.51	0.51	0.51
<b>2020x530x766</b>				
 kg	67.5	69.4	76	76
 m3	0.59	0.59	0.59	0.59
<b>2520x530x766</b>				
 kg	74.8	74.6	98.4	98.4
 m3	0.72	0.72	0.72	0.72
<b>3020x530x766</b>				
 kg	81.2	89.7	106.3	106.3
 m3	0.91	0.91	0.91	0.91

\*\*\*Marble shiny  
upcharge  
Aufpreis für marmor  
glänzend

CONFIGURATION DIAGRAM  
KONFIGURATIONSDIAGRAMM

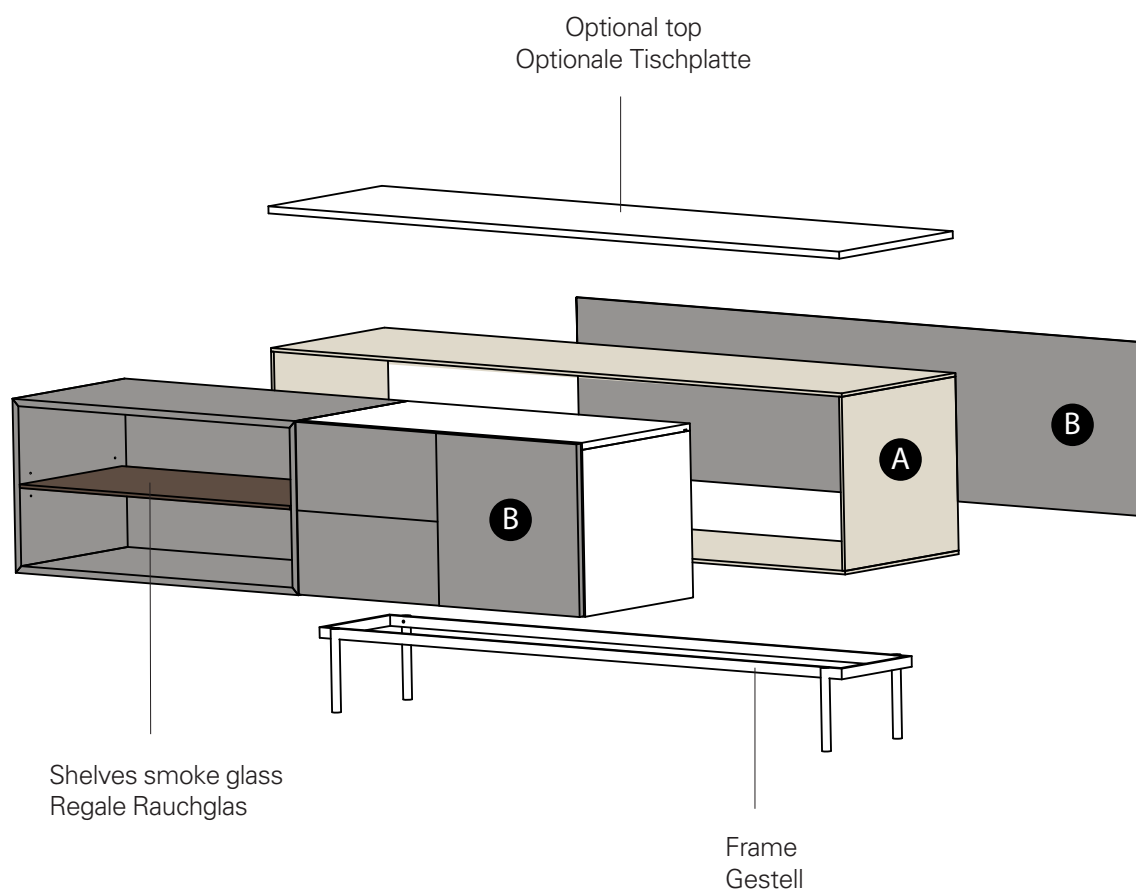

- A** Exterior material / Aussenmaterial
- B** Front and back material / Vorder- und Rückenmaterial

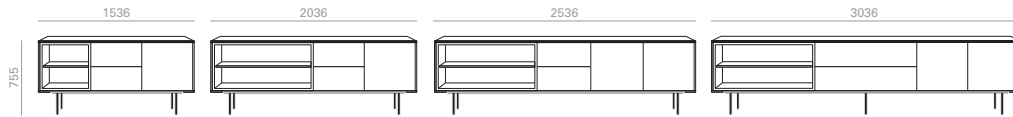

Top measures Größe der Tischplatte	Exterior material Außenmaterial		Front and back material / Vorder- und Rückenmaterial		
			Oak Eiche	Walnut Nussbaum	Lacquered Lackiert
			Ref.	Ref.	Ref.
1536x530x755	Oak Eiche	S600	AP04809	AP04810	AP04811
	kg		148'9	148'9	148'9
	3 boxes / kartons	m3	1,09	1,09	1,09
2036x530x755	Oak Eiche	S600	AP04845	AP04846	AP04847
	kg		166'5	166'5	166'5
	5 boxes / kartons	m3	1,25	1,25	1,25
2536x530x755	Oak Eiche	S600	AP04881	AP04882	AP04883
	kg		181'7	181'7	181'7
	5 boxes / kartons	m3	1,57	1,57	1,57
3036x530x755	Oak Eiche	S600	AP04917	AP04918	AP04919
	kg		208'9	208'9	208'9
	6 boxes / kartons	m3	1,82	1,82	1,82
1536x530x755	Walnut Nussbaum		AP04812	AP04813	AP04814
	kg		148'9	148'9	148'9
	3 boxes / kartons	m3	1,09	1,09	1,09
2036x530x755	Walnut Nussbaum		AP04848	AP04849	AP04850
	kg		166'5	166'5	166'5
	5 boxes / kartons	m3	1,25	1,25	1,25
2536x530x755	Walnut Nussbaum		AP04884	AP04885	AP04886
	kg		181'7	181'7	181'7
	5 boxes / kartons	m3	1,57	1,57	1,57
3036x530x755	Walnut Nussbaum		AP04920	AP04921	AP04922
	kg		208'9	208'9	208'9
	6 boxes / kartons	m3	1,82	1,82	1,82
1536x530x755	Lacquered Lackiert		AP04815	AP04816	AP04817
	kg		148'9	148'9	148'9
	3 boxes / kartons	m3	1,09	1,09	1,09
2036x530x755	Lacquered Lackiert		AP04851	AP04852	AP04853
	kg		166'5	166'5	166'5
	5 boxes / kartons	m3	1,25	1,25	1,25
2536x530x755	Lacquered Lackiert		AP04887	AP04888	AP04889
	kg		181'7	181'7	181'7
	5 boxes / kartons	m3	1,57	1,57	1,57
3036x530x755	Lacquered Lackiert		AP04923	AP04924	AP04925
	kg		208'9	208'9	208'9
	6 boxes / kartons	m3	1,82	1,82	1,82











Polished Chrome upcharge  
1536x530x755  
Aufpreis für Glanzverchromt

Polished Chrome upcharge  
2036x530x755  
Aufpreis für Glanzverchromt

Polished Chrome upcharge  
2536x530x755  
Aufpreis für Glanzverchromt

Polished Chrome upcharge  
3036x530x755  
Aufpreis für Glanzverchromt

Optional table tops /Optionale Tischplatten				
Top measures Grösse der Tischplatte	***Technical Stone 8	***Low Iron Glass Optisch Glas	***Marble M1 Marmor M1	Marble M3 Marmor M3
1520x530x766				
 kg	49.5	56.9	69.5	69.5
 m3	0.51	0.51	0.51	0.51
2020x530x766				
 kg	67.5	69.4	76	76
 m3	0.59	0.59	0.59	0.59
2520x530x766				
 kg	74.8	74.6	98.4	98.4
 m3	0.72	0.72	0.72	0.72
3020x530x766				
 kg	81.2	89.7	106.3	106.3
 m3	0.91	0.91	0.91	0.91

\*\*\*Marble shiny  
upcharge  
Aufpreis für marmor  
glänzend

CONFIGURATION DIAGRAM  
KONFIGURATIONSDIAGRAMM

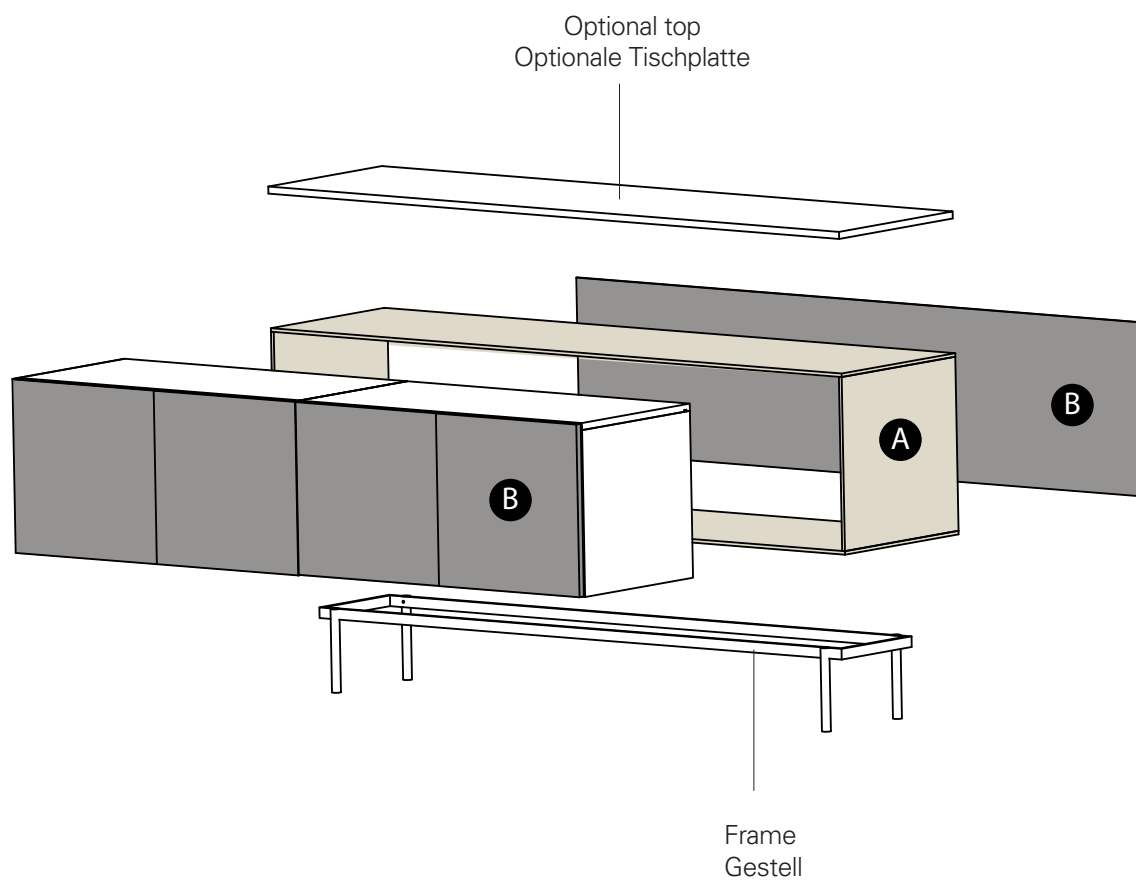

- A** Exterior material / Material exterior
- B** Front and back material / Material frontal y posterior





Top measures Größe der Tischplatte	Exterior material Außenmaterial			Front and back material / Vorder- und Rückenmaterial							
				Oak Eiche		Walnut Nussbaum		Lacquered Lackiert			
				Ref.		Ref.		Ref.			
1536x530x755	Oak Eiche	S600	AP04818		AP04819	AP04820	3.204				
								kg	148'9	148'9	148'9
								2 boxes / kartons	1,09	1,09	1,09
2036x530x755	Oak Eiche	S600	AP04854		AP04855	AP04856	4.296				
								kg	166'5	166'5	166'5
								4 boxes / kartons	1,25	1,25	1,25
2536x530x755	Oak Eiche	S600	AP04890		AP04891	AP04892					
								kg	181'7	181'7	181'7
								4 boxes / kartons	1,57	1,57	1,57
3036x530x755	Oak Eiche	S600	AP04926		AP04927	AP04928					
								kg	208'9	208'9	208'9
								5 boxes / kartons	1,82	1,82	1,82
1536x530x755	Walnut Nussbaum		AP04821		AP04822	AP04823					
	kg							148'9	148'9	148'9	
	2 boxes / kartons							1,09	1,09	1,09	
2036x530x755	Walnut Nussbaum		AP04857		AP04858	AP04859					
	kg							166'5	166'5	166'5	
	4 boxes / kartons							1,25	1,25	1,25	
2536x530x755	Walnut Nussbaum		AP04893		AP04894	AP04895					
	kg							181'7	181'7	181'7	
	4 boxes / kartons							1,57	1,57	1,57	
3036x530x755	Walnut Nussbaum		AP04929		AP04930	AP04931					
	kg							208'9	208'9	208'9	
	5 boxes / kartons							1,82	1,82	1,82	
1536x530x755	Lacquered Lackiert		AP04824		AP04825	AP04826					
	kg							148'9	148'9	148'9	
	2 boxes / kartons							1,09	1,09	1,09	
2036x530x755	Lacquered Lackiert		AP04860		AP04861	AP04862					
	kg							166'5	166'5	166'5	
	4 boxes / kartons							1,25	1,25	1,25	
2536x530x755	Lacquered Lackiert		AP04896		AP04897	AP04898					
	kg							181'7	181'7	181'7	
	4 boxes / kartons							1,57	1,57	1,57	
3036x530x755	Lacquered Lackiert		AP04932		AP04933	AP04934					
	kg							208'9	208'9	208'9	
	5 boxes / kartons							1,82	1,82	1,82	











Polished Chrome upcharge  
1536x530x755  
Aufpreis für Glanzverchromt

Polished Chrome upcharge  
2036x530x755  
Aufpreis für Glanzverchromt

Polished Chrome upcharge  
2536x530x755  
Aufpreis für Glanzverchromt

Polished Chrome upcharge  
3036x530x755  
Aufpreis für Glanzverchromt

Optional table tops /Optionale Tischplatten				
Top measures Grösse der Tischplatte	***Technical Stone 8	***Low Iron Glass Optisch Glas	***Marble M1 Marmor M1	Marble M3 Marmor M3
<b>1520x530x766</b>				
 kg	49.5	56.9	69.5	69.5
 m3	0.51	0.51	0.51	0.51
<b>2020x530x766</b>				
 kg	67.5	69.4	76	76
 m3	0.59	0.59	0.59	0.59
<b>2520x530x766</b>				
 kg	74.8	74.6	98.4	98.4
 m3	0.72	0.72	0.72	0.72
<b>3020x530x766</b>				
 kg	81.2	89.7	106.3	106.3
 m3	0.91	0.91	0.91	0.91

\*\*\*Marble shiny  
upcharge  
Aufpreis für marmor  
glänzend

CONFIGURATION DIAGRAM  
KONFIGURATIONSDIAGRAMM

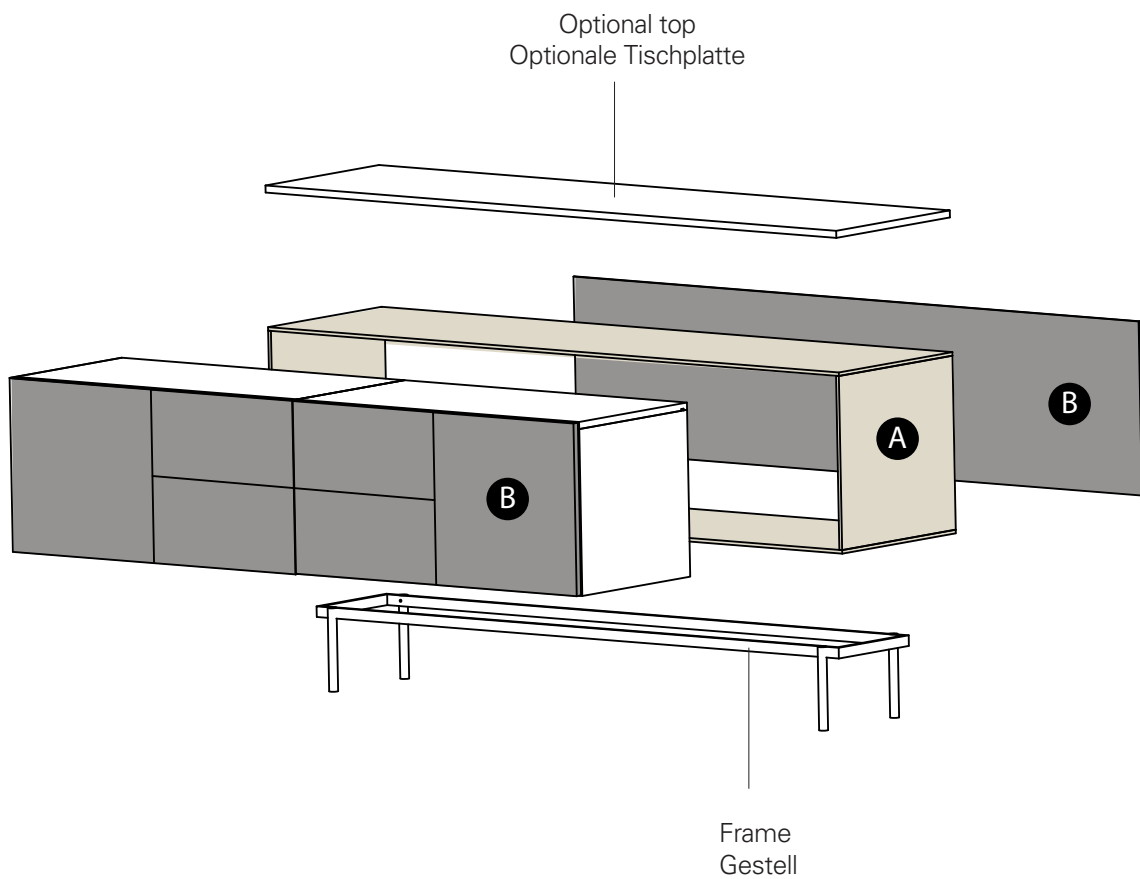

- A** Exterior material / Aussenmaterial
- B** Front and back material / Vorder- und Rückenmaterial

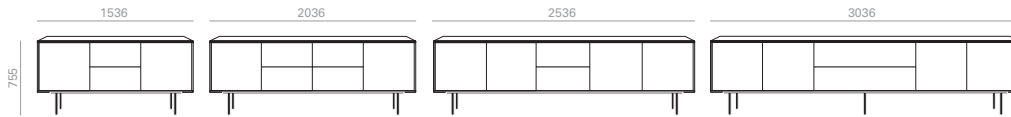

Top measures Größe der Tischplatte	Exterior material Außenmaterial			Front and back material / Vorder- und Rückenmaterial					
				Oak Eiche		Walnut Nussbaum		Lacquered Lackiert	
				Ref.		Ref.		Ref.	
1536x530x755	Oak Eiche	S600		AP04827		AP04828		AP04829	
				kg	148'9	148'9	148'9		
				2 boxes / kartons	m3	1,09	1,09	1,09	
2036x530x755	Oak Eiche	S600		AP04863		AP04864		AP04865	
				kg	166'5	166'5	166'5		
				4 boxes / kartons	m3	1,25	1,25	1,25	
2536x530x755	Oak Eiche	S600		AP04899		AP04900		AP04901	
				kg	181'7	181'7	181'7		
				4 boxes / kartons	m3	1,57	1,57	1,57	
3036x530x755	Oak Eiche	S600		AP04935		AP04936		AP04937	
				kg	208'9	208'9	208'9		
				5 boxes / kartons	m3	1,82	1,82	1,82	
1536x530x755	Walnut Nussbaum			AP04830		AP04831		AP04832	
	kg	148'9		148'9	148'9				
	2 boxes / kartons	m3		1,09	1,09	1,09			
2036x530x755	Walnut Nussbaum			AP04866		AP04867		AP04868	
	kg	166'5		166'5	166'5				
	4 boxes / kartons	m3		1,25	1,25	1,25			
2536x530x755	Walnut Nussbaum			AP04902		AP04903		AP04904	
	kg	181'7		181'7	181'7				
	4 boxes / kartons	m3		1,57	1,57	1,57			
3036x530x755	Walnut Nussbaum			AP04938		AP04939		AP04940	
	kg	208'9		208'9	208'9				
	5 boxes / kartons	m3		1,82	1,82	1,82			
1536x530x755	Lacquered Lackiert			AP04833		AP04834		AP04835	
	kg	148'9		148'9	148'9				
	2 boxes / kartons	m3		1,09	1,09	1,09			
2036x530x755	Lacquered Lackiert			AP04869		AP04870		AP04871	
	kg	166'5		166'5	166'5				
	4 boxes / kartons	m3		1,25	1,25	1,25			
2536x530x755	Lacquered Lackiert			AP04905		AP04906		AP04907	
	kg	181'7		181'7	181'7				
	4 boxes / kartons	m3		1,57	1,57	1,57			
3036x530x755	Lacquered Lackiert			AP04941		AP04942		AP04943	
	kg	208'9		208'9	208'9				
	5 boxes / kartons	m3		1,82	1,82	1,82			











Polished Chrome upcharge  
1536x530x755  
Aufpreis für Glanzverchromt

Polished Chrome upcharge  
2036x530x755  
Aufpreis für Glanzverchromt

Polished Chrome upcharge  
2536x530x755  
Aufpreis für Glanzverchromt

Polished Chrome upcharge  
3036x530x755  
Aufpreis für Glanzverchromt

Optional table tops /Optionale Tischplatten				
Top measures Grösse der Tischplatte	***Technical Stone 8	***Low Iron Glass Optisch Glas	***Marble M1 Marmor M1	Marble M3 Marmor M3
1520x530x766				
 kg	49.5	56.9	69.5	69.5
 m3	0.51	0.51	0.51	0.51
2020x530x766				
 kg	67.5	69.4	76	76
 m3	0.59	0.59	0.59	0.59
2520x530x766				
 kg	74.8	74.6	98.4	98.4
 m3	0.72	0.72	0.72	0.72
3020x530x766				
 kg	81.2	89.7	106.3	106.3
 m3	0.91	0.91	0.91	0.91

\*\*\*Marble shiny  
upcharge  
Aufpreis für marmor  
glänzend

Maximum table heights  
 Maximale Tischhöhen

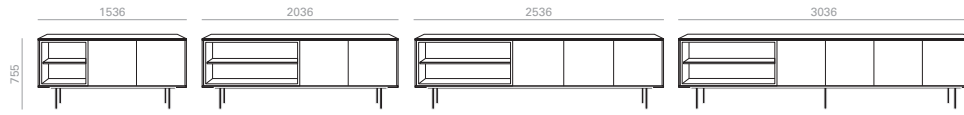

Front and back material		
Oak Eiche	Walnut Nussbaum	Lacquered Lackiert