

Description
Beschreibung

Table program with aluminum frame and rectangular top available in oak, melamine and TP ultramatte laminate in different sizes. It is offered with two types of structure, C-shaped and T-shaped, in white, black or polished aluminum finish. Flip top version.

Ein Programm von Tischen mit Aluminiumstruktur und rechteckiger Tischplatte, erhältlich in Eiche, Melamin und Laminat ultramatte mit TP, in verschiedenen Grössen. Es werden zwei verschiedenen Arten von Strukturen angeboten, C- und T-förmig, in weiss, schwarzer oder polierter Aluminiumausführung. Auch Version mit klappbarer Platte. Verfügbare Optionen: gebogene abgeschrägte Eckplatte zur Verbindung von Tischen, klappbare Tischplatte, Reihenverbinder und Rollen mit Bremssystem.

Wood finish Oak
Holzausführungen
Eiche



Wood lacquer finish
Holzlackausführungen



Aluminum finish
Aluminiumausführungen



Melamine finish
Melaminausführungen



Ultra-matte finish
Ultra-mattausführungen



Power box
Anschlussystem



Intellectual property Geistiges Eigentum

All our collections are protected by international industrial design registries, designs patents, copyrights and intellectual Property laws. Unauthorized use of AW International Property is a criminal offence and can lead to prosecution.
Alle unsere Kollektionen sind durch internationale Industrie-Design Registern, Design Patente, Urheberrecht und geistiges Eigentum rechtlich geschützt. Die unbefugte Nutzung des internationalen Eigentums von AW ist eine Straftat und kann zur Strafverfolgung führen.



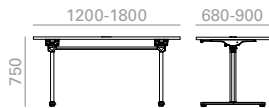

Folding system
upcharge.
Aufpreis für
Klappsystem.

Top measures Grösse der Tischplatte	Table top / Tischplatten											
	Oak Eiche			S600			Melamine Melamin			Ultra-matte TP Ultra-matt TP		
	Ref.			Ref.			Ref.			Ref.		
1200x680	ME2910			ME2925			ME2940					
kg	33'85			33'85			33'85					
2 boxes / kartons m3	0,28			0,28			0,28					
1200x750	ME2911			ME2926			ME2941					
kg	36'44			36'44			36'44					
2 boxes / kartons m3	0,3			0,3			0,3					
1200x900	ME2912			ME2927			ME2942					
kg	40'33			40'33			40'33					
2 boxes / kartons m3	0,35			0,35			0,35					
1500x680	ME2913			ME2928			ME2943					
kg	40'06			40'06			40'06					
2 boxes / kartons m3	0,35			0,35			0,35					
1500x750	ME2914			ME2929			ME2944					
kg	43'3			43'3			43'3					
2 boxes / kartons m3	0,37			0,37			0,37					
1500x900	ME2915			ME2930			ME2945					
kg	48'16			48'16			48'16					
2 boxes / kartons m3	0,43			0,43			0,43					
1800x680	ME2916			ME2931			ME2946					
kg	46'27			46'27			46'27					
2 boxes / kartons m3	0,41			0,41			0,41					
1800x750	ME2917			ME2932			ME2947					
kg	50'16			50'16			50'16					
2 boxes / kartons m3	0,44			0,44			0,44					
1800x900	ME2918			ME2933			ME2948					
kg	55'99			55'99			55'99					
2 boxes / kartons m3	0,51			0,51			0,51					

**Polished
aluminum
upcharge**
Aufpreis für Alu
poliert



Edge legs

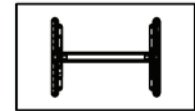

Inset legs

Edge legs

Legs are 152 mm from the edge of the table

Die Beine sind 152 mm von der Tischkante entfernt

Inset legs

Legs are 305 mm from the edge of the table

Die Beine sind 305 mm von der Tischkante entfernt

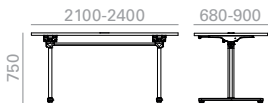

Folding system
upcharge.
Aufpreis für
Klappsystem.

Top measures Grösse der Tischplatte	Table top / Tischplatten											
	Oak Eiche			S600			Melamine Melamin			Ultra-matte TP Ultra-matt TP		
	Ref.			Ref.			Ref.			Ref.		
2100x680	ME2919			ME2934			ME2949					
kg	52'48			52'48			52'48					
2 boxes / kartons m3	0,48			0,48			0,48					
2100x750	ME2920			ME2935			ME2950					
kg	57'02			57'02			57'02					
2 boxes / kartons m3	0,5			0,5			0,5					
2100x900	ME2921			ME2936			ME2951					
kg	63'82			63'82			63'82					
2 boxes / kartons m3	0,59			0,59			0,59					
2400x680	ME2922			ME2937			ME2952					
kg	56'7			56'7			56'7					
2 boxes / kartons m3	0,54			0,54			0,54					
2400x750	ME2923			ME2938			ME2953					
kg	61'88			61'88			61'88					
2 boxes / kartons m3	0,57			0,57			0,57					
2400x900	ME2924			ME2939			ME2954					
kg	69'66			69'66			69'66					
2 boxes / kartons m3	0,68			0,68			0,68					

**Polished
aluminum
upcharge
Aufpreis für Alu
poliert**

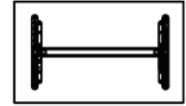

Edge legs

Edge legs

Legs are 152 mm from the edge of the table
Die Beine sind 152 mm von der Tischkante entfernt

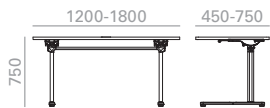

Folding system
upcharge.
Aufpreis für
Klappsystem.

Top measures Grösse der Tischplatte	Table top / Tischplatten											
	Oak Eiche			S600			Melamine Melamin			Ultra-matte TP Ultra-matt TP		
	Ref.			Ref.			Ref.			Ref.		
1200x450	ME3720			ME3735			ME3750					
kg	28'66			28'66			28'66					
2 boxes / kartons	0,28			0,28			0,28					
1200x600	ME3721			ME3736			ME3751					
kg	32'55			32'55			32'55					
2 boxes / kartons	0,28			0,28			0,28					
1200x750	ME3722			ME3737			ME3752					
kg	36'44			36'44			36'44					
2 boxes / kartons	0,3			0,3			0,3					
1500x450	ME3723			ME3738			ME3753					
kg	33'58			33'58			33'58					
2 boxes / kartons	0,35			0,35			0,35					
1500x600	ME3724			ME3739			ME3754					
kg	38'44			38'44			38'44					
2 boxes / kartons	0,35			0,35			0,35					
1500x750	ME3725			ME3740			ME3755					
kg	43'3			43'3			43'3					
2 boxes / kartons	0,37			0,37			0,37					
1800x450	ME3726			ME3741			ME3756					
kg	38'5			38'5			38'5					
2 boxes / kartons	0,41			0,41			0,41					
1800x600	ME3727			ME3742			ME3757					
kg	44'33			44'33			44'33					
2 boxes / kartons	0,41			0,41			0,41					
1800x750	ME3728			ME3743			ME3758					
kg	50'16			50'16			50'16					
2 boxes / kartons	0,44			0,44			0,44					

Polished
aluminum
upcharge
Aufpreis für Alu
poliert

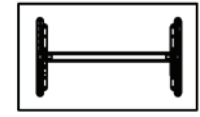

Edge legs

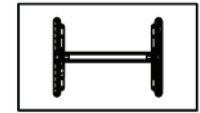

Inset legs

Edge legs

Legs are 152 mm from the edge of the table
Die Beine sind 152 mm von der Tischkante entfernt

Inset legs

Legs are 305 mm from the edge of the table
Die Beine sind 305 mm von der Tischkante entfernt



Folding system
upcharge.
Aufpreis für
Klappsystem.

Top measures Grösse der Tischplatte	Table top / Tischplatten											
	Oak Eiche			S600			Melamine Melamin			Ultra-matte TP Ultra-matt TP		
	Ref.			Ref.			Ref.			Ref.		
2100x450	ME3729			ME3744			ME3759					
kg	43'41			43'41			43'41					
2 boxes / kartons	0,48			0,48			0,48					
2100x600	ME3730			ME3745			ME3760					
kg	50'22			50'22			50'22					
2 boxes / kartons	0,48			0,48			0,48					
2100x750	ME3731			ME3746			ME3761					
kg	57'02			57'02			57'02					
2 boxes / kartons	0,5			0,5			0,5					
2400x450	ME3732			ME3747			ME3762					
kg	46'33			46'33			46'33					
2 boxes / kartons	0,54			0,54			0,54					
2400x600	ME3733			ME3748			ME3763					
kg	54'1			54'1			54'1					
2 boxes / kartons	0,54			0,54			0,54					
2400x750	ME3734			ME3749			ME3764					
kg	61'88			61'88			61'88					
2 boxes / kartons	0,57			0,57			0,57					

Polished
aluminum
upcharge
Aufpreis für Alu
poliert



Edge legs

Edge legs

Legs are 152 mm from the edge of the table
Die Beine sind 152 mm von der Tischkante entfernt

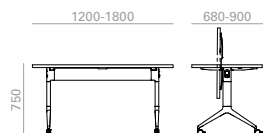

Folding system
upcharge.
Aufpreis für
Klappsystem.

Top measures Grösse der Tischplatte	Table top / Tischplatten						Polished aluminum upcharge Aufpreis für Alu poliert
	Oak Eiche		S600	Melamine Melamin		Ultra-matte TP Ultra-matt TP	
	Ref.			Ref.		Ref.	
1200x680	ME3810			ME3811		ME3812	
kg	33'85			33'85		33'85	
1 box / karton m3	0,28			0,28		0,28	
1200x750	ME3813			ME3814		ME3815	
kg	36'44			36'44		36'44	
1 box / karton m3	0,3			0,3		0,3	
1200x900	ME3816			ME3817		ME3818	
kg	40'33			40'33		40'33	
1 box / karton m3	0,35			0,35		0,35	
1500x680	ME3819			ME3820		ME3821	
kg	40'06			40'06		40'06	
1 box / karton m3	0,35			0,35		0,35	
1500x750	ME3822			ME3823		ME3824	
kg	43'3			43'3		43'3	
1 box / karton m3	0,37			0,37		0,37	
1500x900	ME3825			ME3826		ME3827	
kg	48'16			48'16		48'16	
1 box / karton m3	0,43			0,43		0,43	
1800x680	ME3828			ME3829		ME3830	
kg	46'27			46'27		46'27	
1 box / karton m3	0,41			0,41		0,41	
1800x750	ME3831			ME3832		ME3833	
kg	50'16			50'16		50'16	
1 box / karton m3	0,44			0,44		0,44	
1800x900	ME3834			ME3835		ME3836	
kg	55'99			55'99		55'99	
1 box / karton m3	0,51			0,51		0,51	

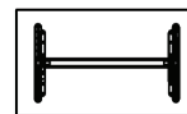

Edge legs

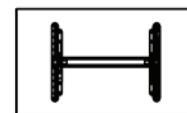

Inset legs

Edge legs

Legs are 152 mm from the edge of the table

Die Beine sind 152 mm von der Tischkante entfernt

Inset legs

Legs are 305 mm from the edge of the table

Die Beine sind 305 mm von der Tischkante entfernt

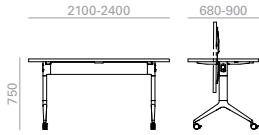

Folding system
upcharge.
Aufpreis für
Klappsystem.

Top measures Grösse der Tischplatte	Table top / Tischplatten											
	Oak Eiche			S600			Melamine Melamin			Ultra-matte TP Ultra-matt TP		
	Ref.			Ref.			Ref.			Ref.		
2100x680	ME3837			ME3838			ME3839					
kg	52'48			52'48			52'48					
1 box / karton m3	0,48			0,48			0,48					
2100x750	ME3840			ME3841			ME3842					
kg	57'02			57'02			57'02					
1 box / karton m3	0,5			0,5			0,5					
2100x900	ME3843			ME3844			ME3845					
kg	63'82			63'82			63'82					
1 box / karton m3	0,59			0,59			0,59					
2400x680	ME3846			ME3847			ME3848					
kg	56'71			56'71			56'71					
1 box / karton m3	0,54			0,54			0,54					
2400x750	ME3849			ME3850			ME3851					
kg	61'88			61'88			61'88					
1 box / karton m3	0,57			0,57			0,57					
2400x900	ME3852			ME3853			ME3854					
kg	69'66			69'66			69'66					
1 box / karton m3	0,68			0,68			0,68					

**Polished
aluminum
upcharge**
Aufpreis für Alu
poliert



Edge legs

Edge legs

Legs are 152 mm from the edge of the table
Las patas están a 152 mm del borde de la mesa

Maximum table heights
Maximale Tischhöhen

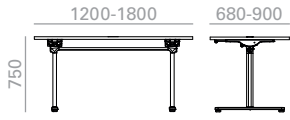
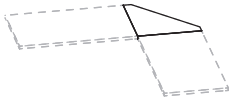

Table top / Tischplatten		
Oak Eiche	Melamine Melamin	Ultra-matteTP Ultra-matt TP



Top measures / Modesty measures Medidas sobre / medidas Modesty		Table top / Sobre		
Edge base	Inset base	Oak Roble	Melamine Melamina	Ultra-matte TP Ultramate TP
1200 / 920 x 350	1200 / 620 x 350			
1500 / 1220 x 350	1500 / 920 x 350			
1800 - 2100 - 2400 / 1520 x 350	1800 / 1220 x 350			



Top measures Größe der Tischplatte	Table top / Tischplatten					
	Oak Eiche		Melamine Melamin		Ultra-matte TP Ultra-matt TP	
	Ref.		Ref.		Ref.	
450x450	SB3835		SB3840		SB3845	
kg	6'37		5'37		5'37	
1 box / karton m3	0,03		0,03		0,03	
600x600	SB3836		SB3841		SB3846	
kg	8'79		8'79		8'79	
1 box / karton m3	0,05		0,05		0,05	
680x680	SB3837		SB3842		SB3847	
kg	10'15		10'15		10'15	
1 box / karton m3	0,06		0,06		0,06	
750x750	SB3838		SB3843		SB3848	
kg	13'2		13'2		13'2	
1 box / karton m3	0,07		0,07		0,07	
900x900	SB3839		SB3844		SB3849	
kg	18'59		18'59		18'59	
1 box / karton m3	0,1		0,1		0,1	

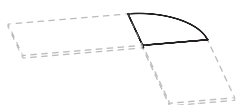

Top measures Grösse der Tischplatte	Table top / Tischplatten					
	Oak Eiche		Melamine Melamin		Ultra-matteTP Ultra-mattTP	
	Ref.		Ref.		Ref.	
450x450	SB3850		SB3855		SB3860	
kg	4'37		4'37		4'37	
1 box / karton m3	0,03		0,03		0,03	
600x600	SB3851		SB3856		SB3861	
kg	7'79		7'79		7'79	
1 box / karton m3	0,05		0,05		0,05	
680x680	SB3852		SB3857		SB3862	
kg	11'51		10'15		10'15	
1 box / karton m3	0,06		0,06		0,06	
750x750	SB3853		SB3858		SB3863	
kg	12'2		12'2		12'2	
1 box / karton m3	0,07		0,07		0,07	
900x900	SB3854		SB3859		SB3864	
kg	17'59		17'59		17'59	
1 box / karton m3	0,1		0,1		0,1	

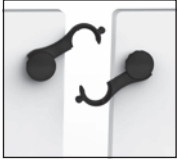

Aufpreis für Reihenverbindung
Linking device upcharge

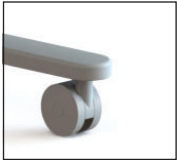

Casters upcharge
Aufpreis für Rollen



Especial leg with wire management
access.
Spezielles Bein mit Kabelverwal-
tungszugang.



Especial beam with wire management
access. Length 1200 mm.
Spezieller Balken mit Kabelverwal-
tungszugang. Länge 1200 mm.

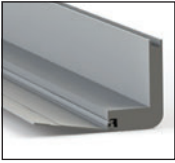

Especial beam with wire management access. Length 1500 mm.

Spezieller Balken mit Kabelverwaltungszugang. Länge 1500 mm.



Especial beam with wire management access. Length 1800-2400 mm.

Spezieller Balken mit Kabelverwaltungszugang. Länge 1800-2400 mm.

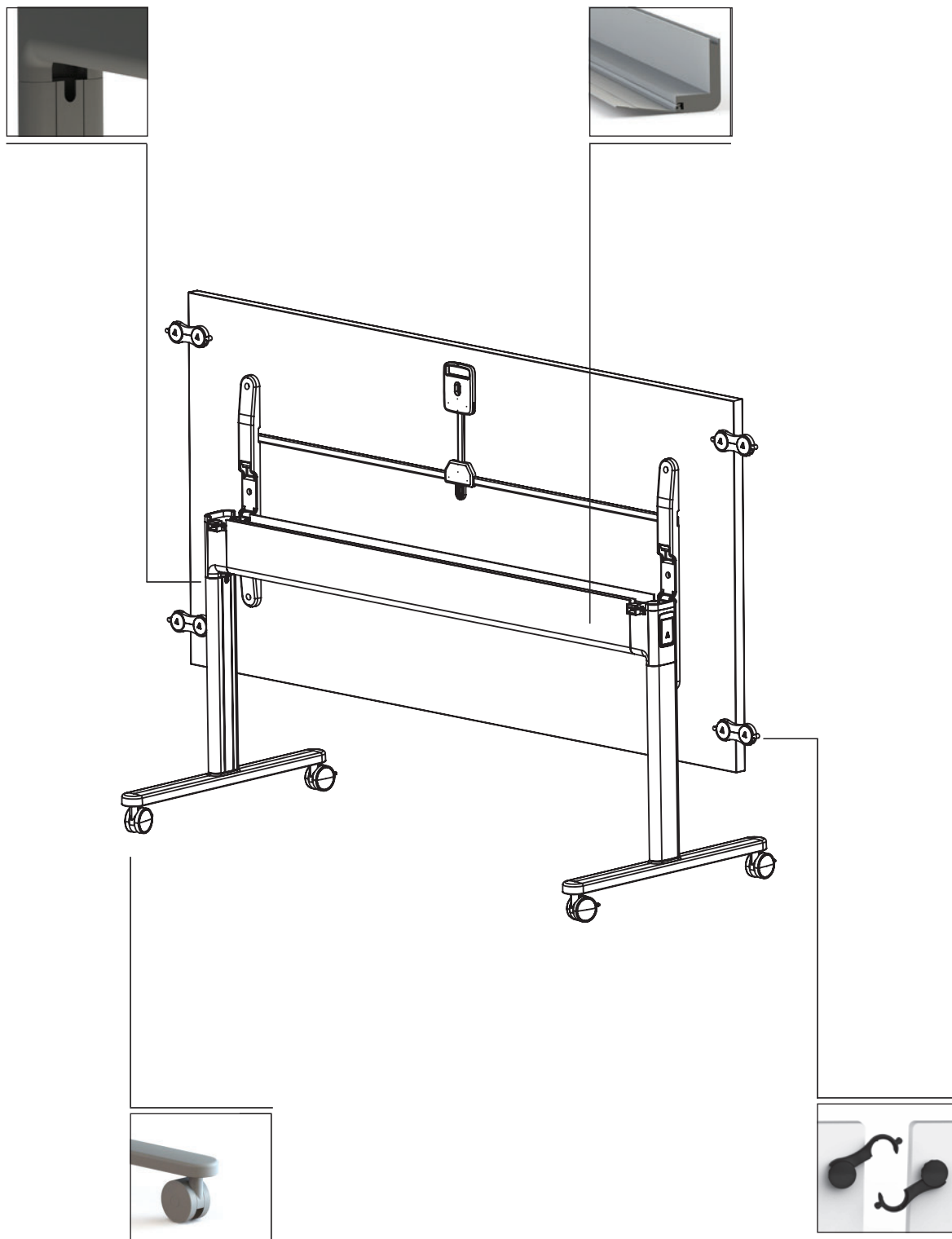

**PS-IN SURFACE /
PS-UNDER TOP**

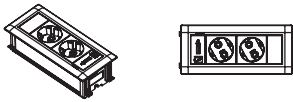

PS0764

PS-IN SURFACE



PS0804



PS0806

PS-QI



PS0714

**Preinstalled (Optional) / Vor-Verkabelung
IN0006**

First installation / Erstinstallation

Second and more installations / Zweite und mehr Installationen

IN-SURFACE/UNDERTOP POWER BOXES POWER BOX IN DER/UNTER TISCHPLATTE

Aluminum power box finished in black.

Einbaumodul aus Aluminium. Ausführung in schwarz.

PS0765

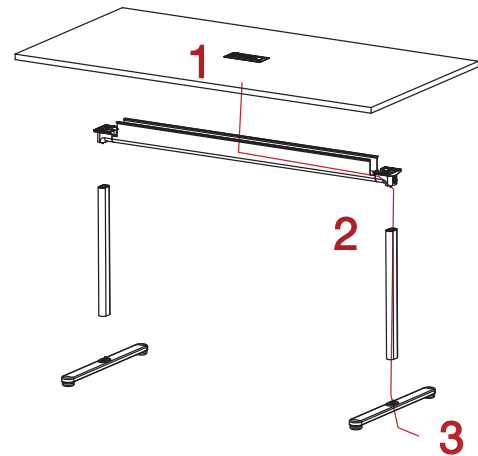
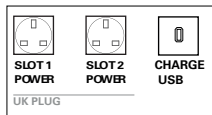
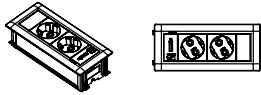

1 POWER BOXES DISTRIBUTION POWER BOX VERTEILUNG

By standard, the position of the system will be in the central of the table, placed horizontally. When there are two system boxes, these will be separated 1/3 between them and placed horizontally. For other options, please contact the Customer Department.

Standardmässig wird das System in der Mitte des Tisches und in Längsrichtung montiert. Wenn zwei Systeme bestellt werden, werden diese in einem Abstand von 1/3 der Gesamtlänge des Tisches und in Längsrichtung positioniert. Für weitere Möglichkeiten, setzen Sie sich mit unserer Verkaufsabteilung in Verbindung.

2 WIRING MANAGEMENT KABEL-VERWALTUNG

Wire pass through an aluminum grommet keeping it hidden. By default color is silver, for other finishings ask the Customer Department.

Das Kabel geht durch eine Aluminium-Tülle. Die Standardausführung ist silber, für weitere Ausführungen setzen Sie sich mit unserer Verkaufsabteilung in Verbindung.

3 CABLEWAY OUT AUSGANG DES KABELS

The cable way out can be performed directly from the power system or through a canal in the base bottom, so that is hidden until it gets to the floor.

Der Kabelausgang wird direkt aus dem System selbst gemacht, so dass das Kabel bis zum Boden versteckt bleibt.

OPTIONAL PREINSTALLED WIRING VOR-VERKABELUNG

IN0006

Preinstalled wiring consists in the addition of the necessary mechanisms to integrate power systems in the table, so that wiring is hidden until the way out in the floor. Necessary grommet are included and 3m cable (from the power system). For other cable dimensions contact the Customer Department.

Die Vor-Verkabelung besteht aus den notwendigen Befestigungsmechanismen um das System in den Tisch zu kaschieren, so dass die Kabeln bis zum Schluss versteckt werden. Es sind die erforderlichen Tüllen und 3-Meter-Kabeln enthalten. Für andere Kabellängen setzen Sie sich mit unserer Verkaufsabteilung in Verbindung.

IN-SURFACE POWER BOXES POWER BOX IN DER TISCHPLATTE

It is a data dynamo with 2 amp dual charging USB. Available in two finishes: black or white.

PS0804

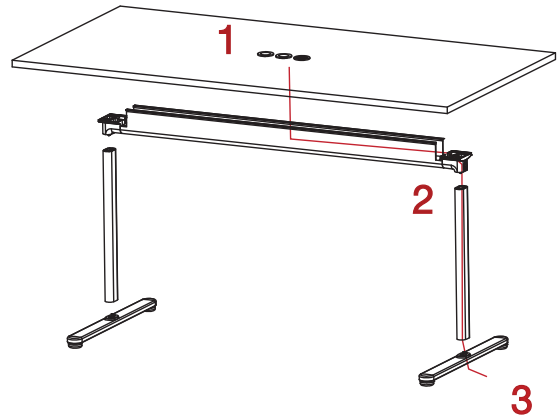
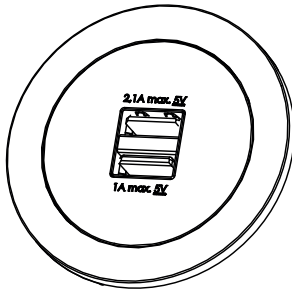

1 POWER BOXES DISTRIBUTION POWER BOX VERTEILUNG

By standard, the position of the system will be in the central of the table, placed horizontally. When there are two system boxes, these will be separated 1/3 between them and placed horizontally. For other options, please contact the Customer Department.

Standardmässig wird das System in der Mitte des Tisches und in Längsrichtung montiert. Wenn zwei Systeme bestellt werden, werden diese in einem Abstand von 1/3 der Gesamtlänge des Tisches und in Längsrichtung positioniert. Für weitere Möglichkeiten, setzen Sie sich mit unserer Verkaufsabteilung in Verbindung.

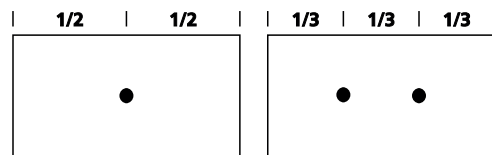

OPTIONAL PREINSTALLED WIRING VOR-VERKABELUNG

IN0006

Preinstalled wiring consists in the addition of the necessary mechanisms to integrate power systems in the table, so that wiring is hidden until the way out in the floor. Necessary grommet are included and 3m cable (from the power system). For other cable dimensions contact the Customer Department.

Die Vor-Verkabelung besteht aus den notwendigen Befestigungsmechanismen um das System in den Tisch zu kaschieren, so dass die Kabeln bis zum Schluss versteckt werden. Es sind die erforderlichen Tüllen und 3 -Meter-Kabel enthalten. Für andere Kabellängen setzen Sie sich mit unserer Verkaufsabteilung in Verbindung. Die Verkabelung kann für die Extra Tische durch die Aluminium-füsse Delta oder 100x100 installiert werden. Bei den Holzfüssen geht die Verkabelung durch die Mitte des Tisches.

The distribution of electricity is entirely configurable; the exit for the cables can be placed inside any leg (A, B, C or D). Please specify the Customer Departmente which leg is to have the cables with reference to the view of the table in the diagram b

Die Verteilung der Elektrifizierung ist konfigurierbar; der Kabelabgang kann am gewünschten Tischfuss (A, B, C oder D) platziert werden. Geben der Verkaufsabteilung Bescheid durch welchen Tischfuss das Kabel gehen muss (siehe Zeichnung).

2 WIRING MANAGEMENT KABEL-VERWALTUNG

Wire pass through an aluminum grommet keeping it hidden. By default color is silver, for other finishings ask the Customer Department.

Das Kabel geht durch eine Aluminium-Tülle. Die Standardausführung ist silber, für weitere Ausführungen setzen Sie sich mit unserer Verkaufsabteilung in Verbindung.

3 CABLE WAY OUT AUSGANG DES KABELS

The cable way out can be performed directly from the power system or through a canal in the base bottom, so that is hidden until it gets to the floor.

Der Kabelausgang wird direkt aus dem System selbst gemacht, so dass das Kabel bis zum Boden versteckt bleibt.

**QI CHARGING POWER BOXES
POWER BOX QI LADEN**

The inductive charging station, allows maximum larger contact surface. Available in two finish: black or white.

PS0714

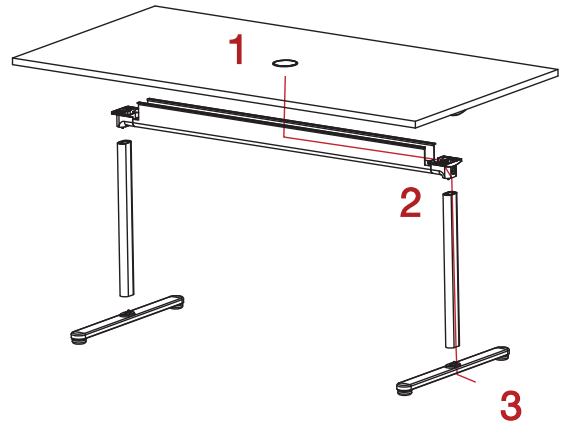
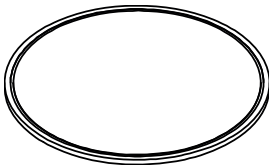

1 POWER BOXES DISTRIBUTION POWER BOX VERTEILUNG

By standard, the position of the system will be in the central of the table, placed horizontally. When there are two system boxes, these will be separated 1/3 between them and placed horizontally. For other options, please contact the Customer Department.

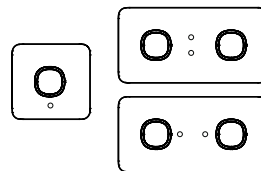

2 WIRING MANAGEMENT KABEL-VERWALTUNG

Wire pass through an aluminum grommet keeping it hidden. By default color is silver, for other finishings ask the Customer Department.

Das Kabel geht durch eine Aluminium-Tülle. Die Standardausführung ist silber, für weitere Ausführungen setzen Sie sich mit unserer Verkaufsabteilung in Verbindung.

**OPTIONAL PREINSTALLED WIRING
VOR-VERKABELUNG**

IN0006

Preinstalled wiring consists in the addition of the necessary mechanisms to integrate power systems in the table, so that wiring is hidden until the way out in the floor. Necessary grommet are included and 3m cable (from the power system). For other cable dimensions contact the Customer Department.

Die Vor-Verkabelung besteht aus den notwendigen Befestigungsmechanismen um das System in den Tisch zu kaschieren, so dass die Kabeln bis zum Schluss versteckt werden. Es sind die erforderlichen Tüllen und 3 -MeterKabel enthalten. Für jedes Untergestell ist ein IN0006 notwendig.

3 CABLE WAY OUT AUSGANG DES KABELS

The cable way out can be performed directly from the power system or through a canal in the base bottom, so that is hidden until it gets to the floor.

Der Kabelausgang wird direkt aus dem System selbst gemacht, so dass das Kabel bis zum Boden versteckt bleibt.