



Description
Beschreibung

Central Eco thermopolymer table base available in different colors or Pure Eco thermopolymer (100% recycled content) available in black and gloss lacquer option. It is offered in different colors and base diameters. Combinable with any model from the Top collection.

Zentrales Eco Thermopolymer Tisch-Untergestell in verschiedenen Farben Erhältlich oder Pure Eco Thermopolymer (100% recycelt) verfügbar in Mattschwarz mit Glanzlackoption. Es wird in verschiedenen Farben und Basisdurchmessern angeboten. Kombinierbar mit jedem Modell aus der Top-Kollektion.

Eco Thermo-polymer finish
Eco Terpolymerausführungen



Pure Eco Thermo-polymer finish

Pure Eco Terpolymerausführungen

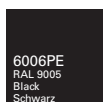

Certificates
Zertifikate

Quality - Resistance UNE EN 15372
Widerstand - Qualitäts

Intellectual property Geistiges Eigentum

All our collections are protected by international industrial design registries, designs patents, copyrights and intellectual Property laws. Unauthorized use of AW International Property is a criminal offence and can lead to prosecution.
Alle unsere Kollektionen sind durch internationale Industrie-Design Registern, Design Patente, Urheberrecht und gesittiges Eigentum rechtlich geschützt. Die unbefugte Nutzung des internationalen Eigentums von AW ist eine Straftat und kann zur Strafverfolgung führen.



Reverse 38

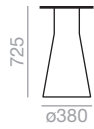

Maximum table top 900x900 / ø1000. Minimum table top 600x600 / ø750. This base is provided with a sand filled counterweight. Amount of sand: 30 kg. The price of the Promo table bases applies only to orders greater than 12 units per color. Counterweight is supplied separately in promotional offers. Suitable for matte finish

Maximale Grösse der Tischplatte 900x900 / ø1000. Minimum Grösse der Tischplatte 600x600 / ø750.

BM4520

Standard
Promo

Standard
Promo

0'12 m3
 28 kg
 x1
1 box / karton



Aufpreis für Hochglanzlackiert
Bright lacquered base up charge

Reverse 50

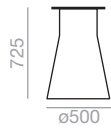

Maximum table top 1400x1400 / ø1500. Minimum table top 700x700 / ø950.

Maximale Grösse der Tischplatte 1400x1400 / ø1500. Minimum Grösse der Tischplatte 700x700 / ø950.

BM4521

0'2 m3
 50 kg
 x1
1 box / karton



Aufpreis für Hochglanzlackiert
Bright lacquered base up charge

Reverse 42



Maximum table top 1100x1100 / ø1200. Minimum table top 600x600 / ø750. This base is provided with a sand filled counterweight. Amount of sand: 50 kg. The price of the Promo table bases applies only to orders greater than 6 units per color. Counterweight is supplied separately in promotional offers. Suitable for matte finish

Maximale Grösse der Tischplatte 1100x1100 / ø1200. Minimum Grösse der Tischplatte 600x600 / ø750.

BM4562

Standard
Promo

Standard
Promo

0'21 m3
 50 kg
 x1
1 box / karton



Aufpreis für Hochglanzlackiert
Bright lacquered base up charge

Reverse 52



Maximum table top 1300x1300 / ø1400. Minimum table top 700x700 / ø950.

Maximale Grösse der Tischplatte 1300x1300 / ø1400. Minimum Grösse der Tischplatte 700x700 / ø950.

BM4569

0'3 m3
 77'5 kg
 x1
1 box / karton



Aufpreis für Hochglanzlackiert
Bright lacquered base up charge

Reverse 60

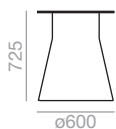

Maximum table top 1600x1600 / ø1800. Minimum table top 800x800 / ø1050.

Maximale Größe der Tischplatte 1600x1600 / ø1800. Minimum Größe der Tischplatte 800x800 / ø1050.

BM4564

0'28 m3
 93 kg
 x1
 1 box / karton



Aufpreis für Hochglanzlackiert
 Bright lacquered base up charge

Reverse 80

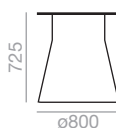

Maximum table top 1900x1900 / ø2100. Minimum table top 800x800 / ø1050.

Maximale Größe der Tischplatte 1900x1900 / ø2100. Minimum Größe der Tischplatte 800x800 / ø1050.

BM4568

0'68 m3
 150 kg
 x1
 1 box / karton



Aufpreis für Hochglanzlackiert
 Bright lacquered base up charge

Counterweight / Füllgewicht



25 kg counterweight for Reverse 38 table bases.

Füllgewicht von 30 kg für Reverse 38 Untergestelle.

CW4524

0'07 m3
 25 kg
 x1
 box / karton

Counterweight / Füllgewicht



50 kg counterweight for Reverse 42 table bases.

Füllgewicht von 50 kg für Reverse 42 Untergestelle.

CW4566

0'07 m3
 25 kg
 x1
 box / karton

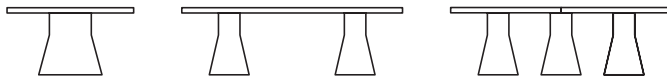

Description

Table program available with different types of bases and tabletops. Eco thermopolymer bases available in different colors or Pure Eco thermopolymer (100% recycled content) available in black and gloss lacquer option. Tops in different shapes and sizes, available in oak, lacquer, laminate, TP laminate, Technical Stone 8, and glass finishes. Table version with base and top in cement finish available according to references.

Beschreibung

Tischprogramm mit verschiedenen Arten von Sockeln und Tischplatten. Erhältlich. Eco-Thermopolymer-Basen in verschiedenen Farben. Erhältlich oder Pure Eco-Thermopolymer (100% recycelt) verfügbar in Mattschwarz mit Glanzlackoption. Tischplatten in verschiedenen Formen und Grössen, Erhältlich in Eichen-, lackierten, laminierten, laminierten TP-, Technical Stone 8- und Glasoberflächen. verfügbare Tischversion mit Sockel und Platte in Zementoptik und Hubversion. Anschlussdose gemäss Referenz Erhältlich.

**Wood finish Oak
Holzausführungen
Eiche**



**Premium finish and
wood lacquers**

**Premium
Ausführungen und
Holzlacke**



**Laminated
Laminat**



**Laminated TP
Laminat TP**

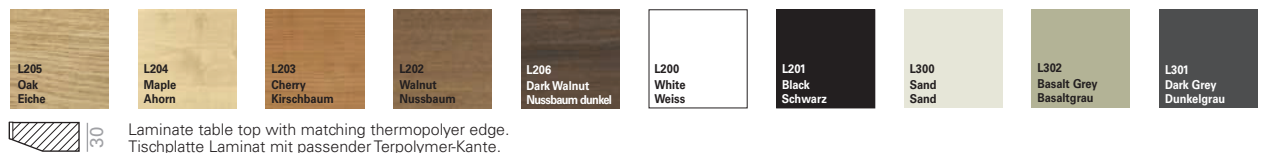

Laminate table top with matching thermopolymer edge.
Tischplatte Laminat mit passender Terpolymer-Kante.

**Glass finish
Glasausführungen**

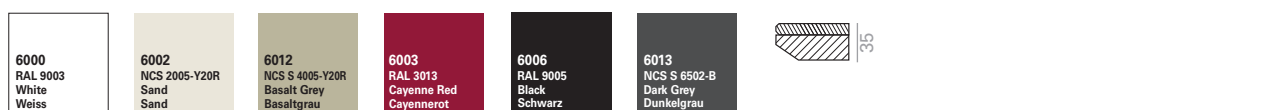

**Ultra-matte finish
Ultra-
mattausführungen**



**Linoleum finish
Linoleumausführungen**

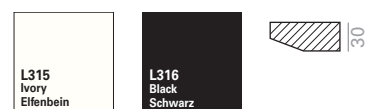

**Technical Stone 8
finish
Technical Stone 8
ausführungen**



**Cement finish
Zementausführungen**



**Eco Thermo-polymer
finish
Eco
Terpolymerausführungen**

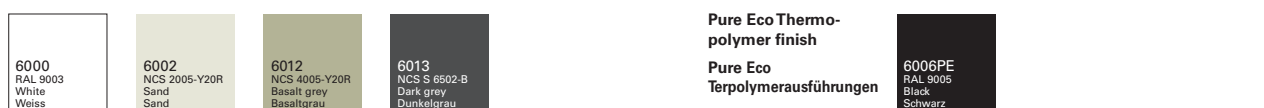

**Pure Eco Thermo-
polymer finish
Pure Eco
Terpolymerausführungen**



**Certificates
Zertifikate**

Quality - Resistance
Widerstand - Qualität

UNE EN 15372

Intellectual property Geistiges Eigentum

All our collections are protected by international industrial design registries, designs patents, copyrights and intellectual Property laws. Unauthorized use of AW International Property is a criminal offence and can lead to prosecution.
Alle unsere Kollektionen sind durch internationale Industrie-Design Registern, Design Patente, Urheberrecht und geistiges Eigentum rechtlich geschützt. Die unbefugte Nutzung des internationalen Eigentums von AW ist eine Straftat und kann zur Strafverfolgung führen.



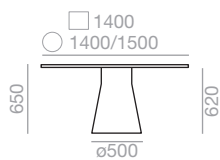

Height adjustable
glides up charged
Aufpreis für
Höhenverstellbare
Gleiter



Preiszuschlag für
Untergestell in
Hochglanzlackierung..
Upcharge for bright
lacquered finish bases.

Amount of sand: 50 kg. Füllgewicht aus Sand: 50 kg.

Table height / Tischhöhe 650									
Top measures Größe der Tischplatte"	Table top / Tischplatten						Top & Base		
	Oak Eiche		s600	Lacquered Lackiert		Low Iron Glass Optisch Glas		Cement Zement	
	Ref.			Ref.		Ref.		Ref.	
1400x1400	ME5500			ME5507		ME5514		ME5723	
kg	52			52		81		133	
2 boxes/ kartons m3	0,55			0,55		1,39		0'55	
ø1400	ME5521			ME5528		ME5535		ME5730	
kg	42			43		43		122	
2 boxes/ kartons m3	0,55			0,55		1,39		0'73	
ø1500	ME5522			ME5529		ME5536		ME5731	
kg	47			48		74		128	
2 boxes/ kartons m3	0,59			0,59		1,54		0'78	
ellipse/ ellipse 1400x1400	ME5542			ME5549		ME5556		ME5737	
kg	42			43		65		132	
2 boxes/ kartons m3	0,55			0,55		1,39		0'73	

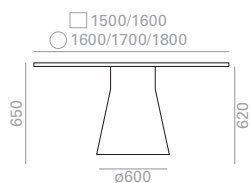

Height adjustable
glides up charged
Aufpreis für
Höhenverstellbare
Gleiter



Preiszuschlag für
Untergestell in
Hochglanzlackierung..
Upcharge for bright
lacquered finish bases.

Amount of sand: 75 kg.
Füllgewicht aus Sand: 75 kg.

Table height / Tischhöhe 650									
Top measures Grösse der Tischplatte"	Table top / Tischplatten						Top & Base		
	Oak Eiche		s600	Lacquered Lackiert		Low Iron Glass Optisch Glas		Cement Zement	
	Ref.			Ref.		Ref.		Ref.	
1500x1500	ME5501			ME5508		ME5515		ME5724	
kg	58		58		92		140		
2 boxes/ kartons m3	0,59		0,59		1,54		0'59		
1600x1600	ME5502			ME5509		ME5516		ME5725	
kg	65		65		103		148		
2 boxes/ kartons m3	0,73		0,73		1,78		0'73		
ø1600	ME5523			ME5530		ME5537		ME5732	
kg	53		53		83		134		
2 boxes/ kartons m3	0,73		0,73		1,78		0'84		
ø1700	ME5524			ME5531		ME5538		ME5733	
kg	59		59		93		141		
2 boxes/ kartons m3	0,78		0,78		4,3		0'9		
ø1800	ME5525			ME5532		ME5539		ME5734	
kg	65		65		103		148		
2 boxes/ kartons m3	0,84		0,84		4,71		0'96		
ellipse/ ellipse 1500x1500	ME5543			ME5550		ME5557		ME5738	
kg	47		48		74		139		
2 boxes/ kartons m3	0,59		0,59		1,54		0'78		
ellipse/ ellipse 1600x1600	ME5544			ME5551		ME5558		ME5739	
kg	53		53		83		139		
2 boxes/ kartons m3	0,73		0,73		1,78		0'84		

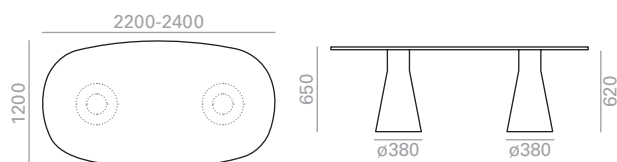

Height adjustable glides up charged
Aufpreis für Höhenverstellbare Gleiter



Preiszuschlag für Untergestell in Hochglanzlackierung..
Upcharge for bright lacquered finish bases.

Amount of sand: 50 kg. (2x25 kg.)
Füllgewicht aus Sand: 50 kg. (2x25 kg.)

Table height / Tischhöhe 650														
Top measures Grösse der Tischplatte"	Table top / Tischplatten												Top & Base	
	Oak Eiche		s600	Lacquered Lackiert		Laminate Laminat		Laminate TP Laminat TP		Top Technical Stone 8		Low Iron Glass Optisch Glas		Cement Zement
	Ref.			Ref.		Ref.		Ref.		Ref.		Ref.		Ref.
2200x1200	ME5563			ME5565		ME5567		ME5569		ME5571		ME5573		ME5744
kg	58		59		59		59		87		89		128	
1 box/ karton m3	0,7		0,7		0,7		0,7		0'7		4		1'24	
2400x1200	ME5564			ME5566		ME5568		ME5570		ME5572		ME5574		ME5745
kg	62		63		63		63		94		96		133	
1 box/ karton m3	0,73		0,73		0,73		0,73		0'73		4'3		1'29	

Table height / Tischhöhe 650						
Top measures Grösse der Tischplatte"	Table top / Tischplatten					
	Linoleum Linoleum		Ultra-matte Ultra-matt		Ultra-matte TP Ultra-matt TP	
	Ref.		Ref.		Ref.	
2200x1200	ME5900		ME5914		ME5928	
kg	127		127		127	
1 box/ karton m3	0,73		0,73		0,73	
2400x1200	ME5901		ME5915		ME5929	
kg	132		132		132	
1 box/ karton m3	0,77		0,77		0,77	

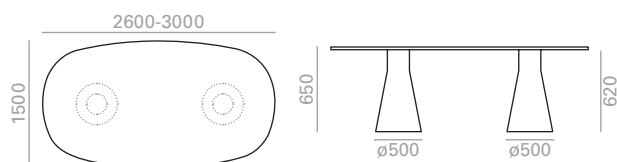

Height adjustable
glides up charged
Aufpreis für?
Höhenverstellbare
Gleiter



Preiszuschlag für
Untergestell in
Hochglanzlackierung..
Upcharge for bright
lacquered finish bases.

Amount of sand: Füllgewicht aus Sand:

Table height / Tischhöhe 650															
Top measures Grösse der Tischplatte"	Table top / Tischplatten												Top & Base		
	Oak Eiche		s600	Lacquered Lackiert		Laminate Laminat		Laminate TP LaminatTP		*Top Technical Stone 8		Low Iron Glass Optisch Glas		Cement Zement	
	Ref.			Ref.		Ref.		Ref.		Ref.		Ref.		Ref.	
2600x1500	ME5575			ME5578		ME5581		ME5584		ME5587		ME5590		ME5746	
kg	80		81		81		81		123		126		155		
1 box/ karton m3	1,24		1,24		1,24		1,24		1'24		5'81		1'34		

2800x1500	ME5576			ME5579		ME5582		ME5585		ME5588		ME5591		ME5747	
kg	85		86		86		86		131		135		161		
1 box/ karton m3	1,29		1,29		1,29		1,29		1'29		6'17		1'89		

3000x1500	ME5577			ME5580		ME5583		ME5586		ME5589		ME5592		ME5748	
kg	183'5		91		91		91		140		144		168		
1 box/ karton m3	1,34		1,34		1,34		1,34		1'34		6'53		2'01		

*Maximum width 1440 mm Ancho máximo 1440 mm

Table height / Tischhöhe 650														
Top measures Grösse der Tischplatte"	Table top / Tischplatten													
	Linoleum Linoleum		Ultra-matte Ultra-matt		Ultra-matte TP Ultra-mattTP									
	Ref.		Ref.		Ref.									
2600x1500	ME5902		ME5916		ME5930									
kg	167		167		167									
1 box/ karton m3	0,93		0,93		0,93									

2800x1500	ME5903		ME5917		ME5931									
kg	175		175		175									
1 box/ karton m3	0,97		0,97		0,97									

3000x1500	ME5904		ME5918		ME5932									
kg	184		184		184									
1 box/ karton m3	1,02		1,02		1,02									

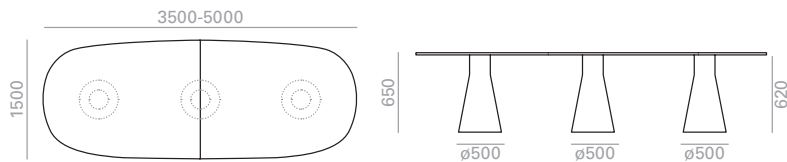

Table height / Tischhöhe 650															
Top measures Grösse der Tischplatte"	Table top / Tischplatten												Top & Base		
	Oak Eiche		s600	Lacquered Lackiert		Laminate Laminat		Laminate TP LaminatTP		*Top Technical Stone 8		Low Iron Glass Optisch Glas		Cement Zement	
	Ref.			Ref.		Ref.		Ref.		Ref.		Ref.		Ref.	
3500x1500	ME5593			ME5595		ME5597		ME5599		ME5601		ME5603		ME5749	
kg	112		112		112		112		169		174		363		
3 boxes/ kartons m3	1,89		1,89		1,89		1,89		1'89		8'38		2'13		
4000x1500	ME5594			ME5596		ME5598		ME5600		ME5602		ME5604		ME5750	
kg	125		126		126		126		190		196		379		
3 boxes/ kartons m3	2,01		2,01		2,01		2,01		2'01		9'28		2'25		
4500x1500	ME5605			ME5607		ME5609		ME5611		ME5613		ME5615		ME5751	
kg	138		139		139		139		212		218		395		
3 boxes/ kartons m3	2,13		2,13		2,13		2,13		2'13		10'18		2'41		
5000x1500	ME5606			ME5608		ME5610		ME5612		ME5614		ME5616		ME5752	
kg	151		152		152		152		233		240		412		
3 boxes/ kartons m3	2,25		2,25		2,25		2,25		2'25		11'08		2'51		

*Maximum width 1440 mm Ancho máximo 1440 mm
Amount of sand: Füllgewicht aus Sand:

Table height / Tischhöhe 650														
Top measures Grösse der Tischplatte"	Table top / Tischplatten													
	Linoleum Linoleum		Ultra-matte Ultra-matt		Ultra-matte TP Ultra-mattTP									
	Ref.		Ref.		Ref.									
3500x1500	ME5905			ME5919		ME5933								
kg	348		348		348									
3 boxes/ kartons m3	1,89		1,89		1,89									
4000x1500	ME5906			ME5920		ME5934								
kg	364		364		364									
3 boxes/ kartons m3	2,01		2,01		2,01									
4500x1500	ME5907			ME5921		ME5935								
kg	381		381		381									
3 boxes/ kartons m3	2,13		2,13		2,13									
5000x1500	ME5908			ME5922		ME5936								
kg	398		398		398									
3 boxes/ kartons m3	2,25		2,25		2,25									

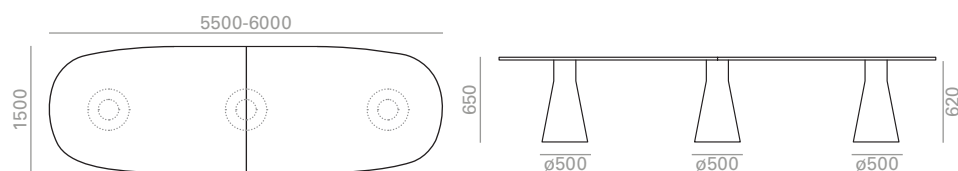

Table height / Tischhöhe 650																
Top measures Grösse der Tischplatte"	Table top / Tischplatten												Top & Base			
	Oak Eiche		s600	Lacquered Lackiert		Laminate Laminat		Laminate TP LaminatTP		*Top Technical Stone 8		Low Iron Glass Optisch Glas		Cement Zement		
	Ref.			Ref.		Ref.		Ref.		Ref.		Ref.		Ref.		
5500x1500	ME5617			ME5619		ME5621		ME5623		ME5625		ME5627		ME5753		
kg	168			169			169			258			266			428
3 boxes/ kartons m3	2,41			2,41			2,41			2'41			12'45			2'41

6000x1500	ME5618			ME5620		ME5622		ME5624		ME5626		ME5628		ME5754		
kg	181			183			183			280			287			444
3 boxes/ kartons m3	2,51			2,51			2,51			2'51			13'39			2'51

*Maximum width 1440 mm Ancho máximo 1440 mm
Amount of sand: Füllgewicht aus Sand:

Table height / Tischhöhe 650														
Top measures Grösse der Tischplatte"	Table top / Tischplatten													
	Linoleum Linoleum		Ultra-matte Ultra-matt		Ultra-matte TP Ultra-matt TP									
	Ref.		Ref.		Ref.									
5500x1500	ME5909			ME5923		ME5937								
kg	415			415			415							
3 boxes/ kartons m3	2,41			2,41			2,41							
6000x1500	ME5910			ME5924		ME5938								
kg	431			431			431							
3 boxes/ kartons m3	2,51			2,51			2,51							

PS-IN SURFACE



PS0735
PS0737 UK



PS0736
PS0738 UK



PS0804

PS-QI



PS0714

Preinstalled (optional) Vor-Verkabelung
IN0006

PS-UNDERTOP



PS0715



PS0787
PS0763 UK



PS0789
PS0760 UK



PS0788
PS0759 UK



PS0790
PS0761 UK

PS-INTREGATED

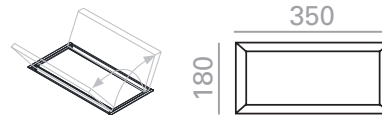

PS0710
PS0712 UK



PS0720
PS0722 UK

SOCKETTOWER ANSCHLUSSSYSTEM

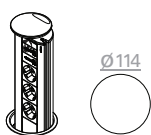

PS0795
PS0797 UK

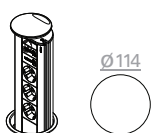

PS0796
PS0798 UK

**IN-SURFACE POWER BOXES
POWER BOX IN DER TISCHPLATTE**

Aluminum power box mounted in the table top with a folding protective lid. Available for any Reverse model. It is served in anodized silver, black or white color, for other finishing, contact the Customer Department. There are two power system sizes available and data slots can be customized according to the below diagram.

Einbaumodul aus Aluminium, integriert in der Oberfläche der Tischplatte, mit Klappdeckel, verfügbar für alle Versionen der Kollektion Reverse. Ausführung in silber eloxiert, schwarz oder weiss, für andere Ausführungen setzen Sie sich mit unserer Verkaufsabteilung in Verbindung. Verfügbar in zwei verschiedene Kastengrößen und mit konfigurierbare Anschlussmöglichkeiten.

**PS0735
PS0737 (UK)**

**PS0736
PS0738 (UK)**

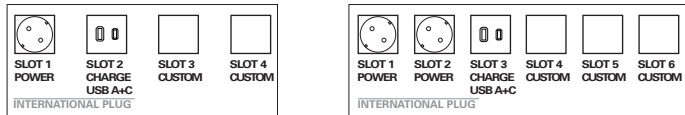

CHOOSE DATA PORT FOR DATA CUSTOM PORT SLOTS

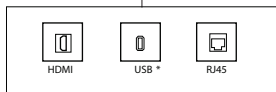

* Only data

**OPTIONAL PREINSTALLED WIRING
VOR-VERKABELUNG**

IN0006

Preinstalled wiring consists in the addition of the necessary mechanisms to integrate power systems in the table, so that wiring is hidden until the way out in the floor. Necessary grommet are included and 3m cable (from the power system). For other cable dimensions contact the Customer Department. Tables with only one base are exempt of this charge, for the rest of tables ask the Customer Department.

Die Vor-Verkabelung besteht aus den notwendigen Befestigungsmechanismen um das System in den Tisch zu kaschieren, so dass die Kabeln bis zum Schluss versteckt werden. Es sind die erforderlichen Tüllen und 3-Meter-Kabel enthalten. Für andere Kabellängen setzen Sie sich mit unserer Verkaufsabteilung in Verbindung.

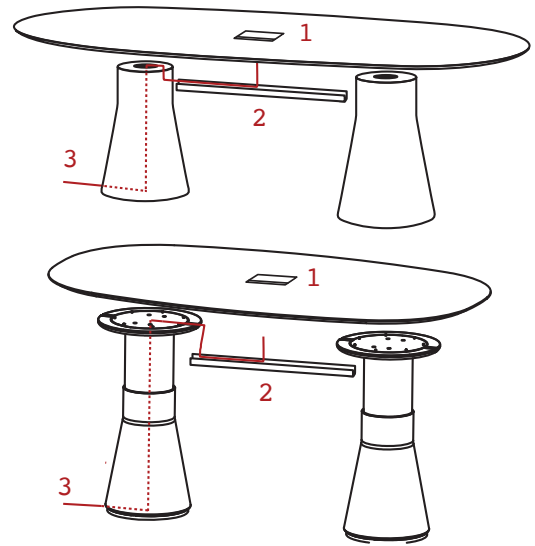

1 POWER BOXES DISTRIBUTION POWER BOX VERTEILUNG

In tables with only one Reverse base power box can't be centered with the base. In tables with more than one base, by default power box is placed in the center of the table and in lengthwise direction. If more than one power box is installed, inform the Customer Department about the desired position.

Bei Tischen mit einem einzigen Untergestell wird die Power-Box exzentrisch positioniert. Bei Tischen mit mehr als einem Untergestell wird die Power-Box in der Mitte des Tisches und in Längsrichtung positioniert. Wenn mehr als eine Power-Box bestellt wird, muss die gewünschte Position mitgeteilt.

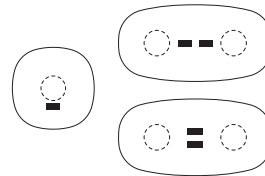

2 WIRING MANAGEMENT KABEL-VERWALTUNG

Wire pass through an aluminum grommet keeping it hidden. By default color is silver, for other finishings ask the Customer Department.

Das Kabel geht durch eine Aluminium-Tülle. Die Standardausführung ist silber, für weitere Ausführungen setzen Sie sich mit unserer Verkaufsabteilung in Verbindung.

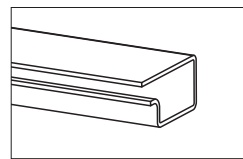

3 CABLE WAY OUT AUSGANG DES KABELS

The cable way out can be performed directly from the power system or thru a canal in the base bottom, so that is hidden until it gets to the floor. Der Kabelausgang wird direkt aus dem System selbst gemacht, so dass das Kabel bis zum Boden versteckt bleibt.

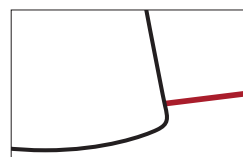

**IN-SURFACE POWER BOXES
POWER BOX IN DER TISCHPLATTE**

It is a data dynamo with 2 amp dual charging USB. Available in two finishes: black or white.

PS0804

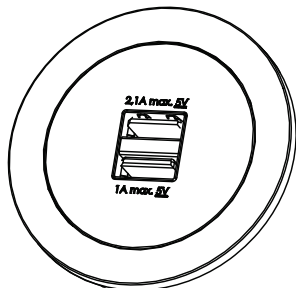

**OPTIONAL PREINSTALLED WIRING
VOR-VERKABELUNG**

IN0006

Preinstalled wiring consists in the addition of the necessary mechanisms to integrate power systems in the table, so that wiring is hidden until the way out in the floor. Necessary grommet are included and 3m cable (from the power system). For other cable dimensions contact the Sales Department. For each wire Reverse base, you must ask for une IN0006 to the Customer Department.

Die Vor-Verkabelung besteht aus den notwendigen Befestigungsmechanismen um das System in den Tisch zu kaschieren, so dass die Kabeln bis zum Schluss versteckt werden. Es sind die erforderlichen Tüllen und 3 -MeterKabel enthalten. Für jedes Untergestell ist ein IN0006 notwendig.

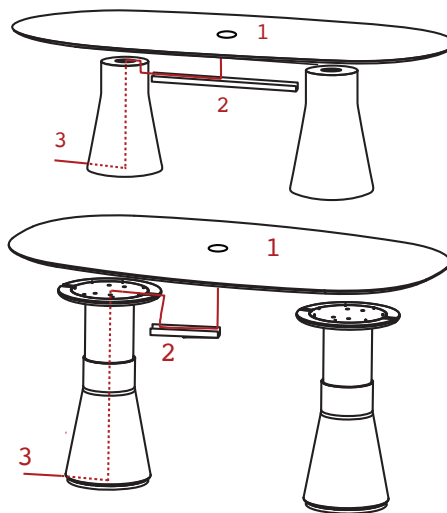

1 POWER BOXES DISTRIBUTION POWER BOX VERTEILUNG

In tables with only one Reverse base power box can't be centered with the base. In tables with more than one base, by default power box is placed in the center of the table and in lengthwise direction. If more than one power box is installed, inform the Customer Department about the desired position.

Bei Tischen mit mehr als einem Untergestell wird die Power-Box in der Mitte des Tisches und in Längsrichtung positioniert. Wenn mehr als eine Power-Box bestellt wird, muss die gewünschte Position mitgeteilt.

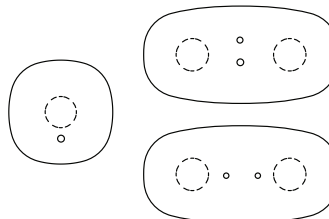

2 WIRING MANAGEMENT KABEL-VERWALTUNG

Wire pass through an aluminum grommet keeping it hidden. By default color is silver, for other finishings ask the Customer Department.

Das Kabel geht durch eine Aluminium-Tülle. Die Standardausführung ist silber, für weitere Ausführungen setzen Sie sich mit unserer Verkaufsabteilung in Verbindung.

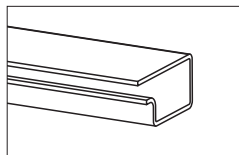

3 CABLE WAY OUT AUSGANG DES KABELS

The cable way out can be performed directly from the power system or thru a canal in the base bottom, so that is hidden until it gets to the floor. Der Kabelausgang wird direkt aus dem System selbst gemacht, so dass das Kabel bis zum Boden versteckt bleibt.

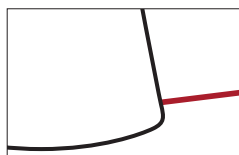

QI CHARGING POWER BOXES POWER BOX QI LADEN

The inductive charging station, allows maximum larger contact surface. Available in two finish: black or white.

PS0714

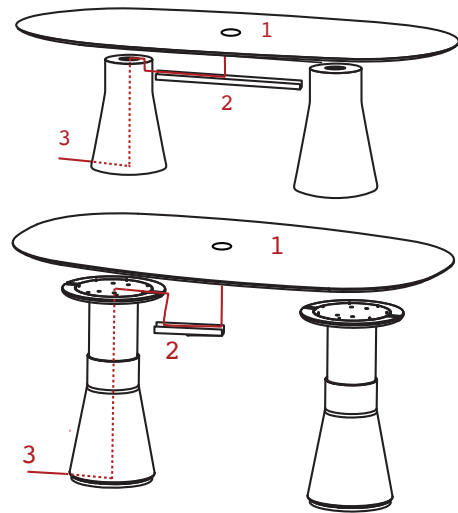
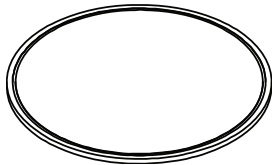

1 POWER BOXES DISTRIBUTION POWER BOX VERTEILUNG

In tables with only one Reverse base power box can't be centered with the base. In tables with more than one base, by default power box is placed in the center of the table and in lengthwise direction. If more than one power box is installed, inform the Customer Department about the desired position.

Bei Tischen mit einem einzigen Untergestell wird die Power-Box exzentrisch positioniert. Bei Tischen mit mehr als einem Untergestell wird die Power-Box in der Mitte des Tisches und in Längsrichtung positioniert. Wenn mehr als eine Power-Box bestellt wird, muss die gewünschte Position mitgeteilt.

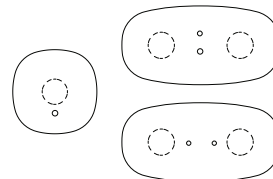

2 WIRING MANAGEMENT KABEL-VERWALTUNG

Wire pass through an aluminum grommet keeping it hidden. By default color is silver, for other finishings ask the Customer Department.

Das Kabel geht durch eine Aluminium-Tülle. Die Standardausführung ist silber, für weitere Ausführungen setzen Sie sich mit unserer Verkaufsabteilung in Verbindung.

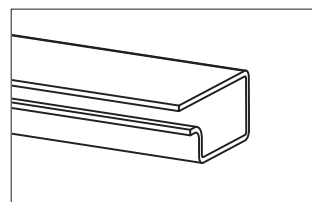

OPTIONAL PREINSTALLED WIRING VOR-VERKABELUNG

IN0006

Preinstalled wiring consists in the addition of the necessary mechanisms to integrate power systems in the table, so that wiring is hidden until the way out in the floor. Necessary grommet are included and 3m cable (from the power system). For other cable dimensions contact the Sales Department. For each wire Reverse base, you must ask for one IN0006 to the Customer Department.

Die Vor-Verkabelung besteht aus den notwendigen Befestigungsmechanismen um das System in den Tisch zu kaschieren, so dass die Kabeln bis zum Schluss versteckt werden. Es sind die erforderlichen Tüllen und 3 -MeterKabel enthalten. Für jedes Untergestell ist ein IN0006 notwendig.

3 CABLE WAY OUT AUSGANG DES KABELS

The cable way out can be performed directly from the power system or thru a canal in the base bottom, so that is hidden until it gets to the floor. Der Kabelausgang wird direkt aus dem System selbst gemacht, so dass das Kabel bis zum Boden versteckt bleibt.

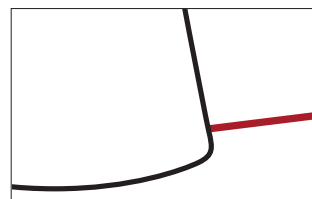

**INTEGRATED POWER BOXES
POWER BOX INTEGRIERT**

The black finish is integrated with the top. Its opening is towards both sides.

Das schwarze Finish ist mit der Oberseite integriert. Seine Öffnung ist nach beiden Seiten gerichtet.

**PS0710
PS0712 (UK)**

**PS0720
PS0722 (UK)**

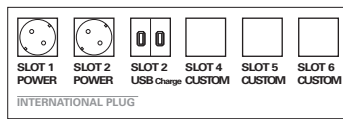
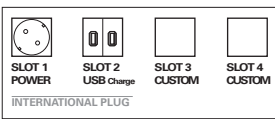
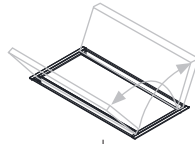
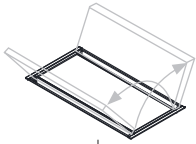

CHOOSE DATA PORT FOR DATA CUSTOM PORT SLOTS

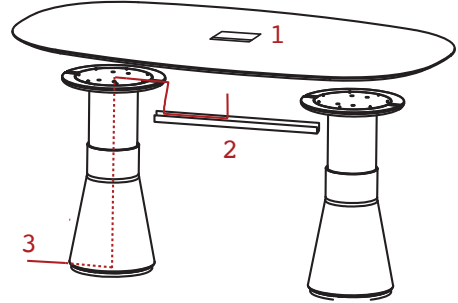
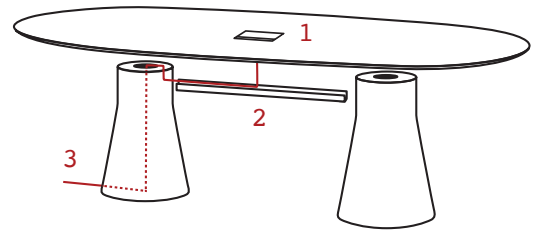
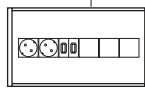
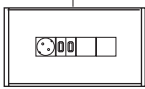
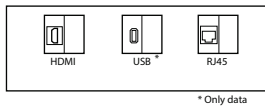

1 POWER BOXES DISTRIBUTION POWER BOX VERTEILUNG

In tables with only one Reverse base power box can't be centered with the base. In tables with more than one base, by default power box is placed in the center of the table and in lengthwise direction. If more than one power box is installed, inform the Customer Department about the desired position.

Bei Tischen mit einem einzigen Untergestell wird die Power-Box exzentrisch positioniert. Bei Tischen mit mehr als einem Untergestell wird die Power-Box in der Mitte des Tisches und in Längsrichtung positioniert. Wenn mehr als eine Power-Box bestellt wird, muss die gewünschte Position mitgeteilt.

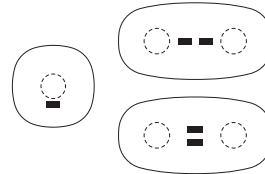

2 WIRING MANAGEMENT KABEL-VERWALTUNG

Wire pass through an aluminum grommet keeping it hidden. By default color is silver, for other finishings ask the Customer Department.

Das Kabel geht durch eine Aluminium-Tülle. Die Standardausführung ist silber, für weitere Ausführungen setzen Sie sich mit unserer Verkaufsabteilung in Verbindung.

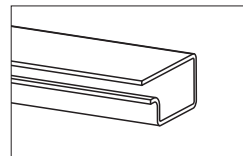

3 CABLE WAY OUT AUSGANG DES KABELS

The cable way out can be performed directly from the power system or thru a canal in the base bottom, so that is hidden until it gets to the floor. Der Kabelausgang wird direkt aus dem System selbst gemacht, so dass das Kabel bis zum Boden versteckt bleibt.

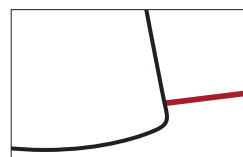

**OPTIONAL PREINSTALLED WIRING
VOR-VERKABELUNG**

IN0006

Preinstalled wiring consists in the addition of the necessary mechanisms to integrate power systems in the table, so that wiring is hidden until the way out in the floor. Necessary grommet are included and 3m cable (from the power system). For other cable dimensions contact the Sales Department. For each wire Reverse base, you must ask for one IN0006 to the Customer Department.

Die Vor-Verkabelung besteht aus den notwendigen Befestigungsmechanismen um das System in den Tisch zu kaschieren, so dass die Kabeln bis zum Schluss versteckt werden. Es sind die erforderlichen Tüllen und 3 -MeterKabel enthalten. Für jedes Untergestell ist ein IN0006 notwendig.

**UNDER-TOP POWER BOXES
POWER BOX UNTER DER TISCHPLATTE**

Power box mounted under the table top. Available in black or white color, for other finishing, contact the Customer Department. There are two power system sizes available and data slots can be customized according to the below diagram.

**PS0787
PS0763 (UK)**

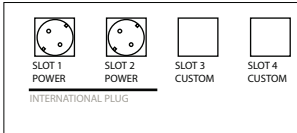

**PS0788
PS0759 (UK)**

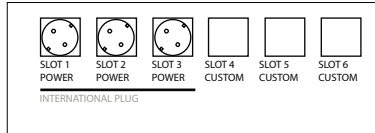

CHOOSE DATA PORT FOR DATA CUSTOM PORT SLOTS

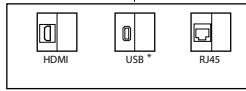

* Only data

**PS0789
PS0760 (UK)**

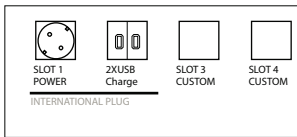

**PS0790
PS0761 (UK)**

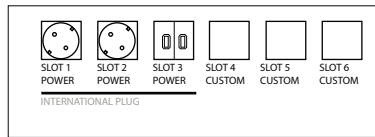

CHOOSE DATA PORT FOR DATA CUSTOM PORT SLOTS

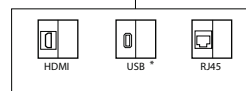

* Only data

**OPTIONAL PREINSTALLED WIRING
VOR-VERKABELUNG**

IN0006

Preinstalled wiring consists in the addition of the necessary mechanisms to integrate power systems in the table, so that wiring is hidden until the way out in the floor. Necessary grommet are included and 3m cable (from the power system). For other cable dimensions contact the Sales Department. For each wire Reverse base, you must ask for one IN0006 to the Customer Department.

Die Vor-Verkabelung besteht aus den notwendigen Befestigungsmechanismen um das System in den Tisch zu kaschieren, so dass die Kabeln bis zum Schluss versteckt werden. Es sind die erforderlichen Tüllen und 3-Meter-Kabel enthalten. Für jedes Untergestell ist ein IN0006 notwendig.

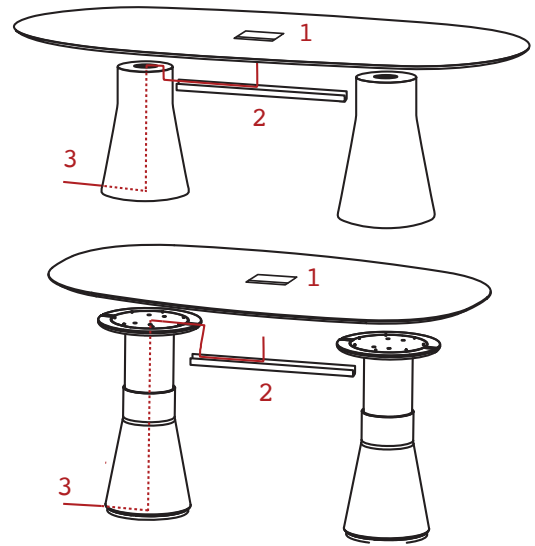

1 POWER BOXES DISTRIBUTION POWER BOX VERTEILUNG

In tables with only one Reverse base power box can't be centered with the base. In tables with more than one base, by default power box is placed in the center of the table and in lengthwise direction. If more than one power box is installed, inform the Customer Department about the desired position.

Bei Tischen mit einem einzigen Untergestell wird die Power-Box exzentrisch positioniert. Bei Tischen mit mehr als einem Untergestell wird die Power-Box in der Mitte des Tisches und in Längsrichtung positioniert. Wenn mehr als eine Power-Box bestellt wird, muss die gewünschte Position mitgeteilt.

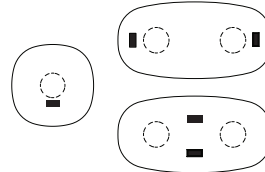

2 WIRING MANAGEMENT KABEL-VERWALTUNG

Wire pass through an aluminum grommet keeping it hidden. By default color is silver, for other finishings ask the Customer Department.

Das Kabel geht durch eine Aluminium-Tülle. Die Standardausführung ist silber, für weitere Ausführungen setzen Sie sich mit unserer Verkaufsabteilung in Verbindung.

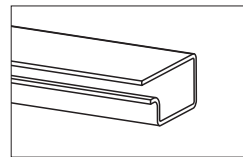

3 CABLE WAY OUT AUSGANG DES KABELS

The cable way out can be performed directly from the power system or thru a canal in the base bottom, so that is hidden until it gets to the floor.

Der Kabelausgang wird direkt aus dem System selbst gemacht, so dass das Kabel bis zum Boden versteckt bleibt.

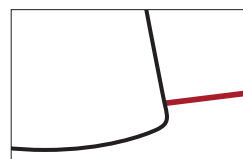

**UNDER-TOP POWER BOXES
POWER BOX UNTER DER TISCHPLATTE**

Under table top USB charging system Ps composed of 2 USB charging, black or white.

PS0715

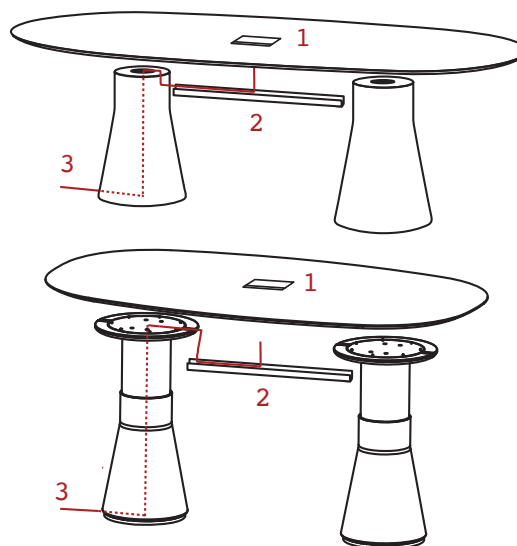
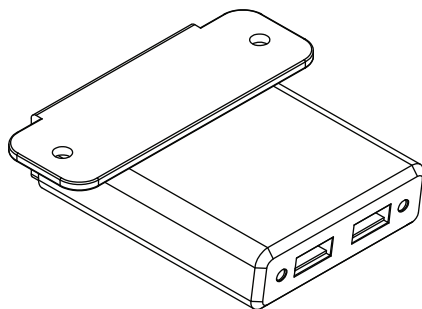

1 POWER BOXES DISTRIBUTION POWER BOX VERTEILUNG

In tables with only one Reverse base power box can't be centered with the base. In tables with more than one base, by default power box is placed in the center of the table and in lengthwise direction. If more than one power box is installed, inform the Customer Department about the desired position.

Bei Tischen mit einem einzigen Untergestell wird die Power-Box exzentrisch positioniert. Bei Tischen mit mehr als einem Untergestell wird die Power-Box in der Mitte des Tisches und in Längsrichtung positioniert. Wenn mehr als eine Power-Box bestellt wird, muss die gewünschte Position mitgeteilt.

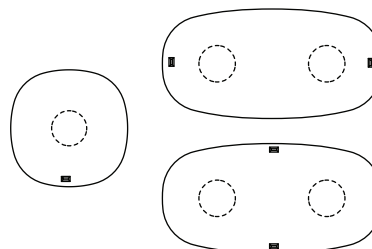

2 WIRING MANAGEMENT KABEL-VERWALTUNG

Wire pass through an aluminum grommet keeping it hidden. By default color is silver, for other finishings ask the Customer Department.

Das Kabel geht durch eine Aluminium-Tülle. Die Standardausführung ist silber, für weitere Ausführungen setzen Sie sich mit unserer Verkaufsabteilung in Verbindung.

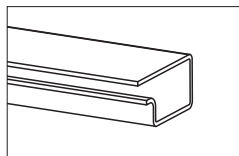

**OPTIONAL PREINSTALLED WIRING
VOR-VERKABELUNG**

IN0006

Preinstalled wiring consists in the addition of the necessary mechanisms to integrate power systems in the table, so that wiring is hidden until the way out in the floor. Necessary grommet are included and 3m cable (from the power system). For other cable dimensions contact the Sales Department. For each wire Reverse base, you must ask for une IN0006 to the Customer Department.

Die Vor-Verkabelung besteht aus den notwendigen Befestigungsmechanismen um das System in den Tisch zu kaschieren, so dass die Kabeln bis zum Schluss versteckt werden. Es sind die erforderlichen Tüllen und 3 -MeterKabel enthalten. Für jedes Untergestell ist ein IN0006 notwendig.

3 CABLE WAY OUT AUSGANG DES KABELS

The cable way out can be performed directly from the power system or thru a canal in the base bottom, so that is hidden until it gets to the floor. Der Kabelausgang wird direkt aus dem System selbst gemacht, so dass das Kabel bis zum Boden versteckt bleibt.

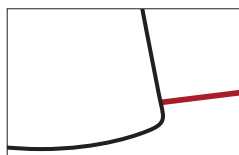

IN-SURFACE SOCKET POWERS ANSCHLUSSSYSTEM IN DER TISCHPLATTE

Socket tower mounted in the table top. The hidden system automatically rises with a slight push. Valid for Reverse tables with bases Reverse 38, 50 and 60. Available in silver, white or black color, for for other finishing, contact the Customer Department.

Anschlussystem mit der Tischplattenoberfläche integriert. Das versteckte elektrische System steigt automatisch wenn man drückt. Erhältlich für Untergestelle Reverse 38, 50 und 60. Es wird in der Ausführung silber, weiss oder schwarz, Für weitere Ausführungen, setzen Sie sich mit unserer Verkaufsabteilung in Verbindung.

PS0795 PS0797 (UK)

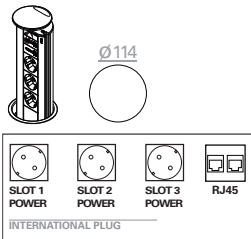

PS0796 PS0798 (UK)

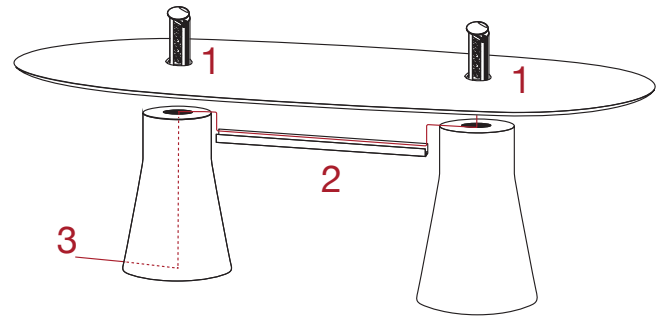
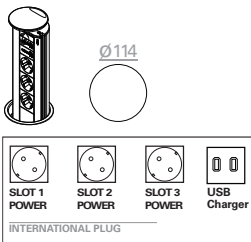

1 POWER BOXES DISTRIBUTION POWER BOX VERTEILUNG

In tables with only one Reverse base power box can't be centered with the base. In tables with more than one base, by default power box is placed in the center of the table and in lengthwise direction. If more than one power box is installed, inform the Customer Department about the desired position.

Bei Tischen mit mehr als einem Untergestell wird die Power-Box in der Mitte des Tisches und in Längsrichtung positioniert. Wenn mehr als eine Power-Box bestellt wird, muss die gewünschte Position mitgeteilt.



2 WIRING MANAGEMENT KABEL-VERWALTUNG

Wire pass through an aluminum grommet keeping it hidden. By default color is silver, for other finishings ask the Customer Department.

Das Kabel geht durch eine Aluminium-Tülle. Die Standardausführung ist silber, für weitere Ausführungen setzen Sie sich mit unserer Verkaufsabteilung in Verbindung.

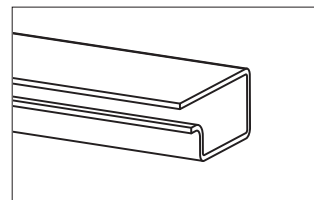

OPTIONAL PREINSTALLED WIRING VOR-VERKABELUNG

IN0006

Preinstalled wiring consists in the addition of the necessary mechanisms to integrate power systems in the table, so that wiring is hidden until the way out in the floor. Necessary grommet are included and 3m cable (from the power system). For other cable dimensions contact the Sales Department. For each wire Reverse base, you must ask for one IN0006 to the Customer Department.

Die Vor-Verkabelung besteht aus den notwendigen Befestigungsmechanismen um das System in den Tisch zu kaschieren, so dass die Kabeln bis zum Schluss versteckt werden. Es sind die erforderlichen Tüllen und 3 -MeterKabel enthalten. Für jedes Untergestell ist ein IN0006 notwendig.

3 CABLE WAY OUT AUSGANG DES KABELS

The cable way out can be performed directly from the power system or thru a canal in the base bottom, so that is hidden until it gets to the floor. Der Kabelausgang wird direkt aus dem System selbst gemacht, so dass das Kabel bis zum Boden versteckt bleibt.

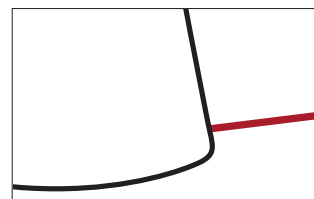

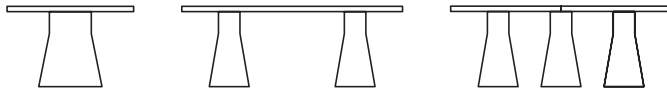

Description
Beschreibung

Range of tables available with different types of bases and table tops. Bases in Eco thermo-polymer available in multiple colors or Pure Eco thermo-polymer (100% recycled) available in black with the option of a glossy lacquer finish. Table tops in different shapes and sizes, available in oak finish, lacquered, laminate, TP laminate, Technical Stone 8, optical glass and matt marble, with option of glossy finish. A table version is available with base and top in cement finish with an elevating option. Connection box available according to model numbers.

Tischprogramm mit verschiedenen Arten von Gertelle und Tischplatten erhältlich. Eco-Thermopolymer-Basen in verschiedenen Farben erhältlich oder Pure Eco-Thermopolymer (100% recycelt) verfu?gbar in Mattschwarz mit Glanzlackoption. Tischplatten in verschiedenen Formen und Grössen, erhältlich in Eichen-, lackierten, laminierten, laminierten TP-, Technical Stone 8- und Glasoberflächen. verfu?gbare Tischversion mit Sockel und Platte in Zementoptik und höhenverstellbaren Versionen. Anschlussdose gemäß Referenz erhältlich.

Wood finish Oak
Holzauisführungen
Eiche



Premium finish and wood lacquers
Premium
Ausführungen und
Holzacke



Laminated
Laminat

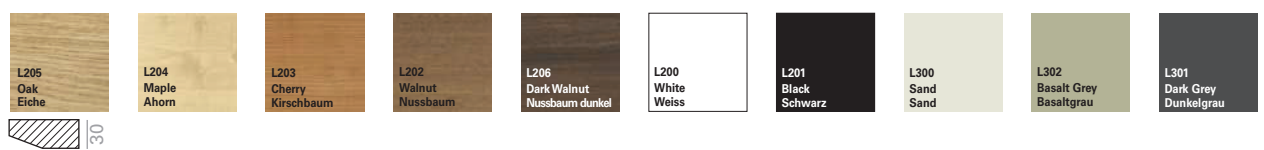

Laminated TP
Laminat TP



Ultra-matte finish
Ultra-
mattausführungen

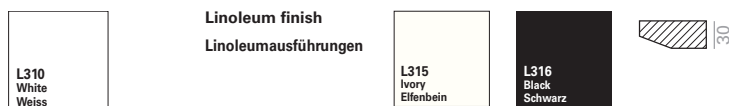

Glass finish
Glasausführungen

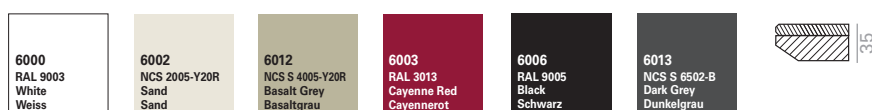

Technical Stone 8 finish
Technical Stone 8
ausführungen

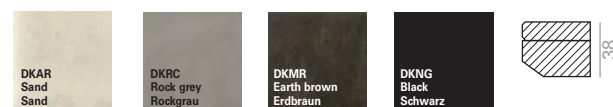

M1 marble finish

M1 Marmor-
Ausführung

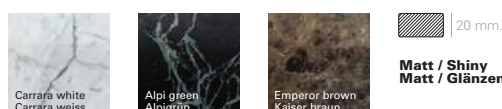

M2 marble finish

M2 Marmor-
Ausführung



M3 marble finish

M3 Marmor-
Ausführung



Certificates
Zertifikate

Quality - Resistance UNE EN 15372
Widerstand - Qualitäts

Intellectual property Geistiges Eigentum

All our collections are protected by international industrial design registries, designs patents, copyrights and intellectual Property laws. Unauthorized use of AW International Property is a criminal offence and can lead to prosecution. Alle unsere Kollektionen sind durch internationale Industrie-Design Register, Design Patente, Urheberrecht und geistiges Eigentum rechtlich geschützt. Die unbefugte Nutzung des internationalen Eigentums von AW ist eine Straftat und kann zur Strafverfolgung führen.



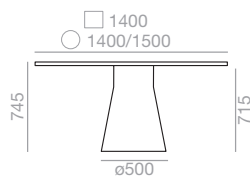

Access panel for wiring up charge.
Aufpreis für Zugangsklappe für die Verkabelung.



Preiszuschlag für Untergestell in Hochglanzlackierung..
Upcharge for bright lacquered finish bases.



Height adjustable glides up charge
Aufpreis für Höhenverstellbare Gleiter

Amount of sand: 50 kg. Füllgewicht aus Sand: 50 kg.

Table height / Tischhöhe 745														
Top measures Größe der Tischplatte"	Table top / Tischplatten												Top & Base	
	Oak Eiche		s600	Lacquered Lackiert		Low Iron Glass Optisch Glas		***Marble M1		***Marble M2		***Marble M3		Cement Cement
	Ref.			Ref.		Ref.		Ref.		Ref.		Ref.		
1400x1400	ME5237			ME5238		ME5249		ME5940		ME5941		ME5942		ME5690
kg	127			127		81		213		213		213		133
2 boxes/ kartons m3	0,68			0,68		1,32		2,96		2'96		2'96		0'68
ø1400	ME5241			ME5242		ME5254		ME5943		ME5944		ME5945		ME5695
kg	118			118		65		186		186		186		122
2 boxes/ kartons m3	0,68			0,68		1,32		2,96		2'96		2'96		0'68
ø1500	ME5243			ME5244		ME5255		ME5946		ME5947		ME5948		ME5696
kg	123			123		74		201		201		201		128
2 boxes/ kartons m3	0,73			0,73		1,45		3,29		3'29		3'29		0'73
ellipse/ ellipse 1400x1400	ME5245			ME5246		ME5261		ME5949		ME5950		ME5951		ME5702
kg	126			126		65		213		213		213		132
2 boxes/ kartons m3	0,68			0,68		1,32		2,96		2'96		2'96		0'68

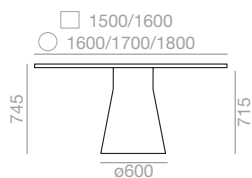

Height adjustable
glides up charged
Aufpreis fu?r
H?henverstellbare
Gleiter



Preiszuschlag f?r
Untergestell in
Hochglanzlackierung..
Upcharge for bright
lacquered finish bases.

Amount of sand: 75 kg. F?llgewicht aus Sand: 75 kg.

Table height / Tischh?he 745														
Top measures Gr?sse der Tischplatte"	Table top / Tischplatten												Top & Base	
	Oak Eiche		s600	Lacquered Lackiert		Low Iron Glass Optisch Glas		***Marble M1		***Marble M2		***Marble M3		Cement Cement
	Ref.			Ref.		Ref.		Ref.		Ref.		Ref.		Ref.
1500x1500	ME5239			ME5240		ME5250		ME5952		ME5953		ME5954		ME5691
kg	134			134		92		281		281		281		140
2 boxes/ kartons m3	0,84			0,84		1,56		2,96		2'96		2'96		0'84
1600x1600	ME5060			ME5075		ME5251		ME5692						
kg	141			141		103		148						
2 boxes/ kartons m3	0,9			0,9		1,7		0'9						
ø1600	ME5065			ME5080		ME5256		ME5697						
kg	128			128		83		134						
2 boxes/ kartons m3	0,9			0,9		1,7		0'9						
ø1700	ME5066			ME5081		ME5257		ME5698						
kg	134			134		93		141						
2 boxes/ kartons m3	0,96			0,96		1,85		0'96						
ø1800	ME5067			ME5082		ME5258		ME5699						
kg	140			140		103		148						
2 boxes/ kartons m3	1,02			1,02		2		1'02						
ellipse/ ellipse 1500x1500	ME5247			ME5248		ME5262		ME5955		ME5956		ME5957		ME5703
kg	133			133		74		281		281		281		139
2 boxes/ kartons m3	0,84			0,84		1,56		2,96		2'96		2'96		0'84
ellipse/ ellipse 1600x1600	ME5070			ME5085		ME5263		ME5704						
kg	133			133		83		139						
2 boxes/ kartons m3	0,57			0,9		1,7		0'9						

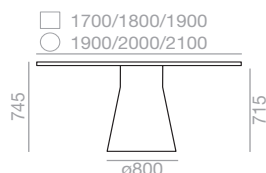

Height adjustable
glides up charged
Aufpreis fu?r
H?henverstellbare
Gleiter



Preiszuschlag f?r
Untergestell in
Hochglanzlackierung..
Upcharge for bright
lacquered finish bases.

Amount of sand: 75 kg.
F?llgewicht aus Sand: 75 kg.

Table height / Tischh?he 745										
Top measures Gr?sse der Tischplatte"	Table top / Tischplatten								Top & Base	
	Oak Eiche		s600	Lacquered Lackiert		Low Iron Glass Optisch Glas		Cement Cement		
	Ref.			Ref.		Ref.		Ref.		
1700x1700	ME5400			ME5401		ME5402		ME5403		
kg	217		217		246		217			
2 boxes/ kartons	1,23		1,23		2,12		1'23			
1800x1800	ME5404			ME5405		ME5406		ME5407		
kg	225		225		256		225			
2 boxes/ kartons	1,3		1,3		2,28		1'3			
1900x1900	ME5408			ME5409		ME5410		ME5411		
kg	234		234		269		234			
2 boxes/ kartons	1,36		1,36		2,44		1'36			
ø1900	ME5412			ME5413		ME5414		ME5415		
kg	216		216		243		216			
2 boxes/ kartons	1,36		1,36		2,44		1'36			
ø2000	ME5416			ME5417		ME5418		ME5419		
kg	223		223		253		223			
2 boxes/ kartons	1,43		1,43		2,62		1'43			
ø2100	ME5420			ME5421		ME5422		ME5423		
kg	231		231		263		231			
2 boxes/ kartons	1,5		1,5		2,62		1'5			
ellipse/ ellipse 1700x1700	ME5424			ME5425		ME5426		ME5427		
kg	217		217		246		217			
2 boxes/ kartons	1,23		1,23		2,12		1'23			
ellipse/ ellipse 1800x1800	ME5428			ME5429		ME5430		ME5431		
kg	225		225		256		225			
2 boxes/ kartons	0,74		1,3		2,28		1'3			
ellipse/ ellipse 1900x1900	ME5432			ME5433		ME5434		ME5435		
kg	234		234		269		234			
2 boxes/ kartons	1,36		1,36		2,44		1'36			

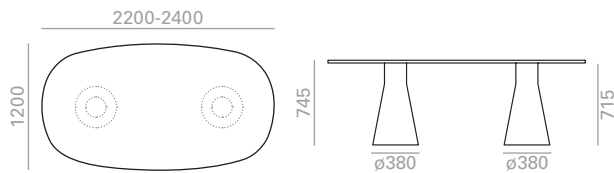

Height adjustable glides up charged Aufpreis für Höhenverstellbare Gleiter



Preiszuschlag für Untergestell in Hochglanzlackierung.. Upcharge for bright lacquered finish bases.

Amount of sand: 50 kg. (2x25 kg.) Füllgewicht aus Sand: 50 kg. (2x25 kg.)

Table height / Tischhöhe 745															
Top measures Grösse der Tischplatte"	Table top / Tischplatten												Top & Base		
	Oak Eiche		s600	Lacquered Lackiert		Laminate Laminat		Laminate TP Laminat TP		Top Technical Stone 8		Low Iron Glass Optisch Glas		Cement Cement	
	Ref.			Ref.		Ref.		Ref.		Ref.		Ref.		Ref.	
2200X1200	ME5010			ME5015		ME5158		ME5185		ME5223		ME5268		ME5709	
kg	126		126		126		126		126		89		128		
2 boxes/ kartons m3	0,84		0,84		0,84		0,84		3'69		3'69		0'84		

2400X1200	ME5011			ME5016		ME5159		ME5186		ME5224		ME5269		ME5710	
kg	131		131		131		131		131		96		133		
2 boxes/ kartons m3	0,88		0,88		0,88		0,88		3'97		3'97		0'88		

Table height / Tischhöhe 745													
Top measures Grösse der Tischplatte"	Table top / Tischplatten												
	Linoleum Linoleum		Ultra-matte Ultra-mat		Ultra-matte TP Ultra-mat TP		***Marble M1		***Marble M2		***Marble M3		
	Ref.		Ref.		Ref.		Ref.		Ref.		Ref.		
2400X1200	ME5791		ME5805		ME5819		ME5961		ME5962		ME5963		
kg	132		132		132		292		292		292		
2 boxes/ kartons m3	0,88		0,88		0,88		4,31		4'31		4'31		

2400X1200	ME5791		ME5805		ME5819		ME5961		ME5962		ME5963		
kg	132		132		132		292		292		292		
2 boxes/ kartons m3	0,88		0,88		0,88		4,31		4'31		4'31		

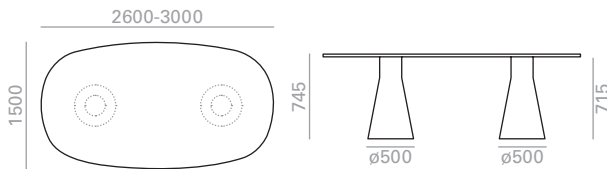

Preiszuschlag für Untergestell in Hochglanzlackierung..
Upcharge for bright lacquered finish bases.

Height adjustable glides up charged
Aufpreis für Höhenverstellbare Gleiter

Access panel for wiring up charge.
Aufpreis für Zugangsklappe für die Verkabelung.

Table height / Tischhöhe 745														
Top measures Grösse der Tischplatte"	Table top / Tischplatten										Top & Base			
	Oak Eiche		s600	Lacquered Lackiert		Laminate Laminat		Laminate TP Laminat TP		*Top Technical Stone 8		Low Iron Glass Optisch Glas	Cement Cement	
	Ref.			Ref.		Ref.		Ref.		Ref.		Ref.		
2600X1500	ME5012			ME5017		ME5160		ME5187		ME5225		ME5270	ME5711	
kg	151			151		151		151		151		126		155
2 boxes/ kartons	1,32			1,32		1,32		1,32		5'34		5'34		1'32
2800X1500	ME5013			ME5018		ME5161		ME5188		ME5226		ME5271	ME5712	
kg	157			157		157		157		157		135		161
2 boxes/ kartons	1,37			1,37		1,37		1,37		5'68		5'68		1'37
3000X1500	ME5014			ME5019		ME5162		ME5189		ME5227		ME5272	ME5713	
kg	162			162		162		162		162		144		168
2 boxes/ kartons	1,43			1,43		1,43		1,43		6'02		6'02		1'43

Amount of sand: 100 kg. (2x250 kg.) Fü-
llgewicht aus Sand: 100 kg. (2x250 kg.)

Table height / Tischhöhe 745												
Top measures Grösse der Tischplatte"	Table top / Tischplatten											
	Linoleum Linoleum		Ultra-matte Ultra-mat	Ultra-matteTP Ultra-matTP	***Marble M1	***Marble M2	***Marble M3					
	Ref.		Ref.		Ref.		Ref.		Ref.		Ref.	
2600X1500	ME5792		ME5806		ME5820		ME5964		ME5965		ME5966	
kg	167		167		167		405		405		405	
2 boxes/ kartons	1,32		1,32		1,32		4,64		4'64		4'64	
2800X1500	ME5793		ME5807		ME5821		ME5967		ME5968		ME5969	
kg	175		175		175		423		423		423	
2 boxes/ kartons	1,37		1,37		1,37		4,87		4'87		4'87	
3000X1500	ME5794		ME5808		ME5822		ME5970		ME5971		ME5972	
kg	184		184		184		467		467		467	
2 boxes/ kartons	1,43		1,43		1,43		6,11		6'11		6'11	

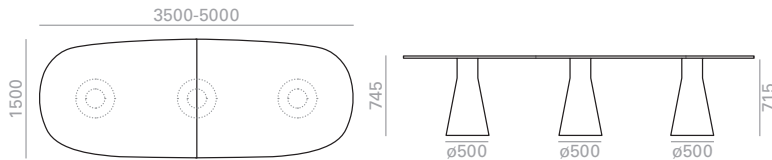

Preiszuschlag für Untergestell in Hochglanzlackierung..
Upcharge for bright lacquered finish bases.

Height adjustable glides up charged
Aufpreis für Höhenverstellbare Gleiter

Access panel for wiring up charge.
Aufpreis für Zugangsklappe für die Verkabelung.

Table height / Tischhöhe 745													
Top measures Grösse der Tischplatte"	Table top / Tischplatten											Top & Base	
	Oak Eiche		s600	Lacquered Lackiert		Laminate Laminat		Laminate TP Laminat TP		*Top Technical Stone 8		Low Iron Glass Optisch Glas	Cement Cement
	Ref.			Ref.		Ref.		Ref.		Ref.		Ref.	
3500x1500	ME5020			ME5029		ME5163		ME5190		ME5228		ME5273	ME5714
kg	345			345			345			345		174	363
3 boxes/ kartons m3	2,18			2,18			2,18			7'41		3'45	2'18
4000x1500	ME5021			ME5030		ME5164		ME5191		ME5229		ME5274	ME5715
kg	360			360			360			360		196	379
3 boxes/ kartons m3	2,31			2,31			2,31			8'65		3'41	2'31
4500x1500	ME5022			ME5031		ME5165		ME5192		ME5230		ME5275	ME5716
kg	374			374			371			371		218	395
3 boxes/ kartons m3	2,45			2,45			2,45			9'01		3'67	2'45
5000x1500	ME5023			ME5032		ME5166		ME5193		ME5231		ME5276	ME5717
kg	389			389			389			389		240	412
3 boxes/ kartons m3	2,58			2,58			2,58			10'35		10'35	2'58

Amount of sand: 150 kg. (3x15 kg.) Füllgewicht aus Sand: 150 kg. (3x15 kg.)

*Maximum width 1440 mm Ancho máximo 1440 mm

Table height / Tischhöhe 745												
Top measures Grösse der Tischplatte"	Table top / Tischplatten											
	Linoleum Linoleum		Ultra-matte Ultra-mat		Ultra-matteTP Ultra-mat TP		***Marble M1	***Marble M2	***Marble M3			
	Ref.		Ref.		Ref.		Ref.		Ref.		Ref.	
3500x1500	ME5795		ME5809		ME5823		ME5973		ME5974		ME5975	
kg	348		348		348		564	564	564			
3 boxes/ kartons m3	2,18		2,18		2,18		7,26	7'26	7'26			
4000x1500	ME5796		ME5810		ME5824		ME5976		ME5977		ME5978	
kg	364		364		364		611	611	611			
3 boxes/ kartons m3	2,31		2,31		2,31		8,32	8'32	8'32			
4500x1500	ME5797		ME5811		ME5825		ME5979		ME5980		ME5981	
kg	381		381		381		658	658	658			
3 boxes/ kartons m3	2,45		2,45		2,45		9,19	9'19	9'19			
5000x1500	ME5798		ME5812		ME5826		ME5982		ME5983		ME5984	
kg	398		398		398		735	735	735			
3 boxes/ kartons m3	2,58		2,58		2,58		9,98	9'98	9'98			

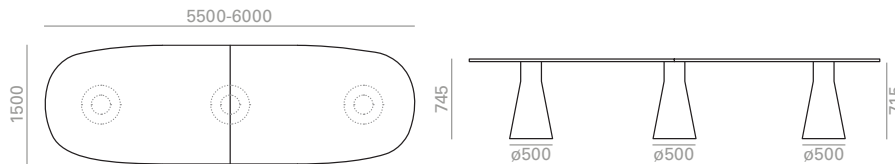

Amount of sand: 150 kg. (3x15 kg.)
Füllgewicht aus Sand: 150 kg. (3x15 kg.)

Table height / Tischhöhe 745															
Top measures Größe der Tischplatte	Table top / Tischplatten												Top & Base		
	Oak Eiche		s600	Lacquered Lackiert		Laminate Laminat		Laminate TP Laminat TP		*Top Technical Stone 8		Low Iron Glass Optisch Glas		Cement Cement	
	Ref.			Ref.		Ref.		Ref.		Ref.		Ref.		Ref.	
5500x1500	ME5024			ME5033		ME5167		ME5194		ME5232		ME5277		ME5718	
kg	407			407		408		408		439		266		428	
3 boxes/ kartons m3	2,72			2,72		2,72		2,72		11'2		11'2		2'72	

6000x1500	ME5025			ME5034		ME5168		ME5195		ME5233		ME5278		ME5719	
kg	422			422		422		422		422		287		444	
3 boxes/ kartons m3	2,86			2,86		2,86		2,86		12'05		12'05		2'86	

*Maximum width 1440 mm Ancho máximo 1440 mm

Table height / Tischhöhe 745													
Top measures Größe der Tischplatte	Table top / Tischplatten												
	Linoleum Linoleum		Ultra-matte Ultra-mat		Ultra-matte TP Ultra-mat TP		***Marble M1		***Marble M2		***Marble M3		
	Ref.		Ref.		Ref.		Ref.		Ref.		Ref.		
5500x1500	ME5799		ME5813		ME5827		ME5985		ME5986		ME5987		
kg	415		415		415		782		782		782		
3 boxes/ kartons m3	2,72		2,72		2,72		10,97		10'97		10'97		

6000x1500	ME5800		ME5814		ME5828		ME5988		ME5989		ME5990		
kg	431		431		431		879		879		879		
3 boxes/ kartons m3	2,86		2,86		2,86		11,78		11'78		11'78		

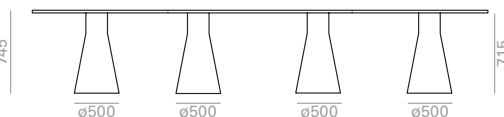
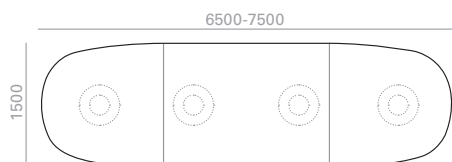

Preiszuschlag für Untergestell in Hochglanzlackierung..
Upcharge for bright lacquered finish bases.



Height adjustable glides up charget
Aufpreis für Höhenverstellbare Gleiter

Amount of sand: 200 kg. (4x50 kg.)
Füllgewicht aus Sand: 200 kg. (4x50 kg.)

Table height / Tischhöhe 745															
Top measures Grösse der Tischplatte"	Table top / Tischplatten												Top & Base		
	Oak Eiche		s600	Lacquered Lackiert		Laminate Laminat		LaminateTP LaminatTP		*Top Technical Stone 8		Low Iron Glass Optisch Glas		Cement Cement	
	Ref.			Ref.		Ref.		Ref.		Ref.		Ref.		Ref.	
6500x1500	ME5026			ME5035		ME5169		ME5196		ME5234		ME5279		ME5720	
kg	515		515		515		515		515		313		543		
4 boxes/ kartons m3	3,01		3,01		3,01		3,01		13'21		13'21		3'01		
7000x1500	ME5027			ME5036		ME5170		ME5197		ME5235		ME5280		ME5721	
kg	529		529		529		529		529		335		560		
4 boxes/ kartons m3	3,15		3,15		3,15		3,15		14'07		14'07		3'15		
7500x1500	ME5028			ME5037		ME5171		ME5198		ME5236		ME5281		ME5722	
kg	544		544		544		544		544		357		576		
4 boxes/ kartons m3	3,29		3,29		3,29		3,29		14'94		14'94		3'29		

*Maximum width 1440 mm Ancho máximo 1440 mm

Table height / Tischhöhe 745														
Top measures Grösse der Tischplatte"	Table top / Tischplatten													
	Linoleum Linoleum		Ultra-matte Ultra-mat		Ultra-matteTP Ultra-matTP		***Marble M1		***Marble M2		***Marble M3			
	Ref.		Ref.		Ref.		Ref.		Ref.		Ref.			
6500x1500	ME5801		ME5815		ME5829		ME5991		ME5992		ME5993			
kg	525		525		525		936		936		936			
4 boxes/ kartons m3	3,01		3,01		3,01		13,69		13'69		13'69			
7000x1500	ME5802		ME5816		ME5830		ME5994		ME5995		ME5996			
kg	542		542		542		983		983		983			
4 boxes/ kartons m3	3,15		3,15		3,15		14,05		14'05		14'05			
7500x1500	ME5803		ME5817		ME5831		ME5997		ME5998		ME5999			
kg	558		558		558		1075		1075		1075			
4 boxes/ kartons m3	3,29		3,29		3,29		14,94		14'94		14'94			

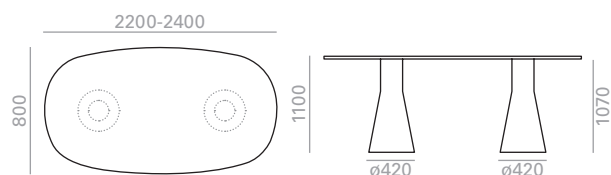

Preiszuschlag für Untergestell in Hochglanzlackierung..
Upcharge for bright lacquered finish bases.



Height adjustable glides up charged
Aufpreis für Höhenverstellbare Gleiter

Amount of sand: 50 kg. (2x25 kg.)
Füllgewicht aus Sand: 50 kg. (2x25 kg.)

Table height / Tischhöhe 1100														
Top measures Grösse der Tischplatte"	Table top / Tischplatten												Top & Base	
	Oak Eiche		s600	Lacquered Lackiert		Laminate Laminat		Laminate TP Laminat TP		Top Technical Stone 8		Low Iron Glass Optisch Glas		Cement Cement
	Ref.			Ref.		Ref.		Ref.		Ref.		Ref.		Ref.
2200x800	ME9750			ME9752		ME9754		ME9756		ME9758		ME9760		ME9762
kg	102		102		102		102		102		118		102	
2 boxes/ kartons m3	0,81		0,81		0,81		0,81		2'86		1'18		0'81	
2400x800	ME9751			ME9753		ME9755		ME9757		ME9759		ME9761		ME9763
kg	105		105		105		105		105		124		105	
2 boxes/ kartons m3	0,84		0,84		0,84		0,84		2'86		1'24		0'84	

Table height / Tischhöhe 1100						
Top measures Grösse der Tischplatte"	Table top / Tischplatten					
	Linoleum Linoleum		Ultra-matte Ultra-mat		Ultra-matte TP Ultra-mat TP	
	Ref.		Ref.		Ref.	
2200x800	ME9764		ME9766		ME9768	
kg	102		102		102	
2 boxes/ kartons m3	0,81		0,81		0,81	
2400x800	ME9765		ME9767		ME9769	
kg	105		105		105	
2 boxes/ kartons m3	0,84		0,84		0,84	

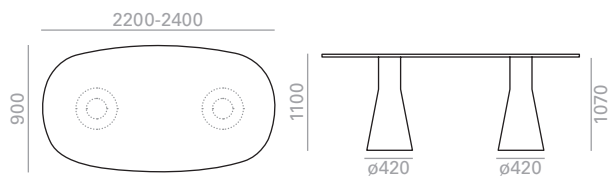

Preiszuschlag für Untergestell in Hochglanzlackierung..
Upcharge for bright lacquered finish bases.



Height adjustable glides up charget
Aufpreis für Höhenverstellbare Gleiter

Amount of sand: 50 kg. (2x25 kg.)
Füllgewicht aus Sand: 50 kg. (2x25 kg.)

Table height / Tischhöhe 1100														
Top measures Grösse der Tischplatte"	Table top / Tischplatten												Top & Base	
	Oak Eiche		s600	Lacquered Lackiert		Laminate Laminat		Laminate TP Laminat TP		Top Technical Stone 8		Low Iron Glass Optisch Glas		Cement Cement
	Ref.			Ref.		Ref.		Ref.		Ref.		Ref.		Ref.
2200x800	ME9770			ME9772		ME9774		ME9776		ME9778		ME9780		ME9782
kg	107			107			107			107			126	
2 boxes/ kartons m3	1,52			1,52			1,52			4'12			3'62	
2400x800	ME9771			ME9773		ME9775		ME9777		ME9779		ME9781		ME9783
kg	111			111			111			111			132	
2 boxes/ kartons m3	1,56			1,56			1,56			4'36			3'82	

Table height / Tischhöhe 1100						
Top measures Grösse der Tischplatte"	Table top / Tischplatten					
	Linoleum Linoleum		Ultra-matte Ultra-mat		Ultra-matte TP Ultra-mat TP	
	Ref.		Ref.		Ref.	
2200x800	ME9784		ME9786		ME9788	
kg	107		107		107	
2 boxes/ kartons m3	1,52		1,52		1,52	
2400x800	ME9785		ME9787		ME9789	
kg	111		111		111	
2 boxes/ kartons m3	1,56		1,56		1,56	

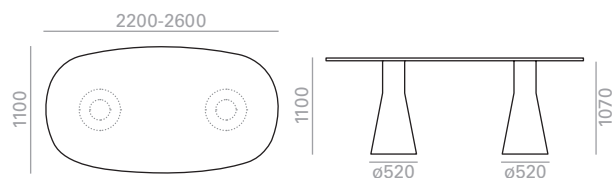

Preiszuschlag für Untergestell in Hochglanzlackierung..
Upcharge for bright lacquered finish bases.



Height adjustable glides up charged
Aufpreis für Höhenverstellbare Gleiter

Amount of sand: 100 kg. (2x250 kg.)
Füllgewicht aus Sand: 100 kg. (2x250 kg.)

Table height / Tischhöhe 1100															
Top measures Grösse der Tischplatte"	Table top / Tischplatten												Top & Base		
	Oak Eiche		s600	Lacquered Lackiert		Laminate Laminat		LaminateTP LaminatTP		Top Technical Stone 8		Low Iron Glass Optisch Glas		Cement Cement	
	Ref.			Ref.		Ref.		Ref.		Ref.		Ref.		Ref.	
2200X1100	ME9790			ME9793		ME9796		ME9799		ME9802		ME9805		ME9808	
kg	127		127		127		127		127		127		127		
2 boxes/ kartons	1,34		1,34		1,34		1,34		3'98		1'77		1'34		
2400X1100	ME9791			ME9794		ME9797		ME9800		ME9803		ME9806		ME9809	
kg	132		132		132		132		132		157		132		
2 boxes/ kartons	1,38		1,38		1,38		1,38		4'21		1'85		1'38		
2600X1100	ME9792			ME9795		ME9798		ME9801		ME9804		ME9807		ME9810	
kg	137		137		137		137		137		165		137		
2 boxes/ kartons	1,42		1,42		1,42		1,42		4'47		4'51		1'42		

Table height / Tischhöhe 1100														
Top measures Grösse der Tischplatte"	Table top / Tischplatten													
	Linoleum Linoleum		Ultra-matte Ultra-mat		Ultra-matteTP Ultra-matTP									
	Ref.		Ref.		Ref.									
2200X1100	ME9811		ME9814		ME9817									
kg	127		127		127									
2 boxes/ kartons	1,34		1,34		1,34									
2400X1100	ME9812		ME9815		ME9818									
kg	132		132		132									
2 boxes/ kartons	1,38		1,38		1,38									
2600X1100	ME9813		ME9816		ME9819									
kg	137		137		137									
2 boxes/ kartons	1,42		1,42		1,42									

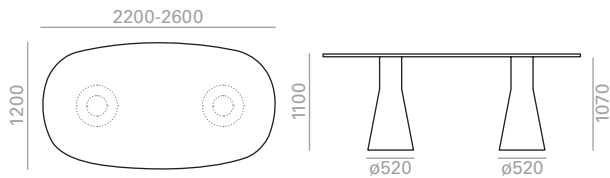

Preiszuschlag für Untergestell in Hochglanzlackierung..
Upcharge for bright lacquered finish bases.



Height adjustable glides up charged
Aufpreis für Höhenverstellbare Gleiter

Amount of sand: 100 kg. (2x250 kg.)
Füllgewicht aus Sand: 100 kg. (2x250 kg.)

Table height / Tischhöhe 1100														
Top measures Grösse der Tischplatte"	Table top / Tischplatten												Top & Base	
	Oak Eiche		s600	Lacquered Lackiert		Laminate Laminat		LaminateTP LaminatTP		Top Technical Stone 8		Low Iron Glass Optisch Glas		Cement Cement
	Ref.			Ref.		Ref.		Ref.		Ref.		Ref.		
2200X1200	ME9820			ME9823		ME9826		ME9829		ME9832		ME9835	ME9838	
kg	132		132		132		132		132		132		132	
2 boxes/ kartons	1,38		1,38		1,38		1,38		4'22		1'87		1'38	
2400X1200	ME9821			ME9824		ME9827		ME9830		ME9833		ME9836	ME9839	
kg	138		138		138		138		138		165		138	
2 boxes/ kartons	1,42		1,42		1,42		1,42		4'5		1'96		1'42	
2600X1200	ME9822			ME9825		ME9828		ME9831		ME9834		ME9837	ME9840	
kg	144		144		144		144		144		173		144	
2 boxes/ kartons	1,47		1,47		1,47		1,47		4'78		2'04		1'47	

Table height / Tischhöhe 1100													
Top measures Grösse der Tischplatte"	Table top / Tischplatten												
	Linoleum Linoleum		Ultra-matte Ultra-mat		Ultra-matteTP Ultra-matTP								
	Ref.		Ref.		Ref.								
2200X1200	ME9841		ME9844		ME9847								
kg	132		132		132								
2 boxes/ kartons	1,38		1,38		1,38								
2400X1200	ME9842		ME9845		ME9848								
kg	138		138		138								
2 boxes/ kartons	1,42		1,42		1,42								
2600X1200	ME9843		ME9846		ME9849								
kg	144		144		144								
2 boxes/ kartons	1,47		1,47		1,47								

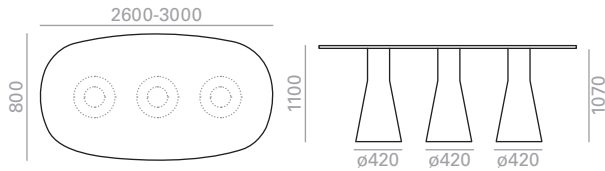

Amount of sand: 75 kg. (3x25 kg.)
Füllgewicht aus Sand: 75 kg. (3x25 kg.)

Table height / Tischhöhe 1100														
Top measures Grösse der Tischplatte"	Table top / Tischplatten												Top & Base	
	Oak Eiche		s600	Lacquered Lackiert		Laminate Laminat		Laminate TP Laminat TP		Top Technical Stone 8		Low Iron Glass Optisch Glas		Cement Cement
	Ref.			Ref.		Ref.		Ref.		Ref.		Ref.		
2600x800	ME9850			ME9853		ME9856		ME9859		ME9862		ME9865	ME9868	
kg	109		109		109		109		109		109		109	
2 boxes/ kartons	1,56		1,56		1,56		1,56		3'94		3'94		1'56	
2800x800	ME9851			ME9854		ME9857		ME9860		ME9863		ME9866	ME9869	
kg	113		113		113		113		113		134		113	
2 boxes/ kartons	1,59		1,59		1,59		1,59		4'14		4'14		1'59	
3000x800	ME9852			ME9855		ME9858		ME9861		ME9864		ME9867	ME9870	
kg	117		117		117		117		117		139		117	
2 boxes/ kartons	1,62		1,62		1,62		1,62		4'34		4'34		1'62	

Table height / Tischhöhe 1100													
Top measures Grösse der Tischplatte"	Table top / Tischplatten												
	Linoleum Linoleum		Ultra-matte Ultra-mat		Ultra-matte TP Ultra-mat TP								
	Ref.		Ref.		Ref.								
2600x800	ME9871		ME9874		ME9877								
kg	109		109		109								
2 boxes/ kartons	1,56		1,56		1,56								
2800x800	ME9872		ME9875		ME9878								
kg	113		113		113								
2 boxes/ kartons	1,59		1,59		1,59								
3000x800	ME9873		ME9876		ME9879								
kg	117		117		117								
2 boxes/ kartons	1,62		1,62		1,62								

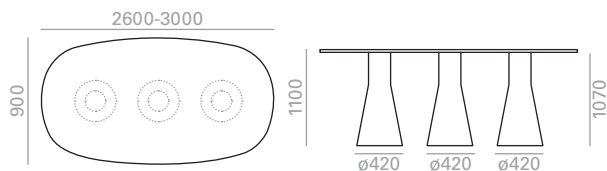

Preiszuschlag für Untergestell in Hochglanzlackierung..
Upcharge for bright lacquered finish bases.



Height adjustable glides up charged
Aufpreis für Höhenverstellbare Gleiter

Amount of sand: 75 kg. (3x25 kg.)
Füllgewicht aus Sand: 75 kg. (3x25 kg.)

Table height / Tischhöhe 1100														
Top measures Grösse der Tischplatte"	Table top / Tischplatten												Top & Base	
	Oak Eiche		s600	Lacquered Lackiert		Laminate Laminat		Laminate TP Laminat TP		Top Technical Stone 8		Low Iron Glass Optisch Glas		Cement Cement
	Ref.			Ref.		Ref.		Ref.		Ref.		Ref.		
2600x900	ME9880			ME9883		ME9886		ME9889		ME9892		ME9895	ME9898	
kg	115		115		115		115		115		115		115	
2 boxes/ kartons	1,61		1,61		1,61		1,61		4'22		4'22		1'61	
2800x900	ME9881			ME9884		ME9887		ME9890		ME9893		ME9896	ME9899	
kg	119		119		119		119		119		143		119	
2 boxes/ kartons	1,64		1,64		1,64		1,64		4'44		4'44		1'64	
3000x900	ME9882			ME9885		ME9888		ME9891		ME9894		ME9897	ME9900	
kg	124		124		124		124		124		149		124	
2 boxes/ kartons	1,33		1,33		1,33		1,33		4'66		4'66		1'33	

Table height / Tischhöhe 1100														
Top measures Grösse der Tischplatte"	Table top / Tischplatten													
	Linoleum Linoleum		Ultra-matte Ultra-mat		Ultra-matte TP Ultra-mat TP									
	Ref.		Ref.		Ref.									
2600x900	ME9901		ME9904		ME9907									
kg	115		115		115									
2 boxes/ kartons	1,26		1,26		1,26									
2800x900	ME9902		ME9905		ME9908									
kg	119		119		119									
2 boxes/ kartons	1,29		1,29		1,29									
3000x900	ME9903		ME9906		ME9909									
kg	124		124		124									
2 boxes/ kartons	1,33		1,33		1,33									

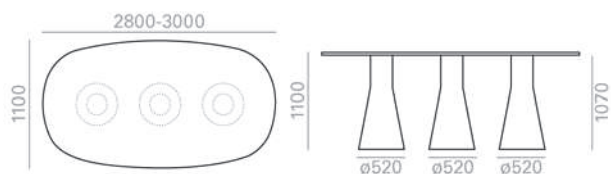

Preiszuschlag für Untergestell in Hochglanzlackierung..
Upcharge for bright lacquered finish bases.



Height adjustable glides up charged
Aufpreis für Höhenverstellbare Gleiter

Amount of sand: 150 kg. (3x15 kg.)
Füllgewicht aus Sand: 150 kg. (3x15 kg.)

Table height / Tischhöhe 1100													
Top measures Größe der Tischplatte"	Table top / Tischplatten											Top & Base	
	Oak Eiche		s600	Lacquered Lackiert		Laminate Laminat		LaminateTP LaminatTP		Top Technical Stone 8		Low Iron Glass Optisch Glas	Cement Cement
	Ref.			Ref.		Ref.		Ref.		Ref.		Ref.	
2800X1100	ME9910			ME9912		ME9914		ME9916		ME9918		ME9920	ME9922
kg	143		143		143		143		143		172	143	
2 boxes/ kartons m3	2,21		2,21		2,21		2,21		5'51		5'51	2'21	
3000X1100	ME9911			ME9913		ME9915		ME9917		ME9919		ME9921	ME9923
kg	148		148		148		148		148		179	148	
2 boxes/ kartons m3	2,25		2,25		2,25		2,25		5'64		5'64	2'25	

Table height / Tischhöhe 1100												
Top measures Größe der Tischplatte"	Table top / Tischplatten											
	Linoleum Linoleum		Ultra-matte Ultra-mat		Ultra-matteTP Ultra-matTP							
	Ref.		Ref.		Ref.							
2800X1100	ME9924		ME9926		ME9928							
kg	143		143		143							
2 boxes/ kartons m3	2,21		2,21		2,21							
3000X1100	ME9925		ME9927		ME9929							
kg	148		148		148							
2 boxes/ kartons m3	2,25		2,25		2,25							

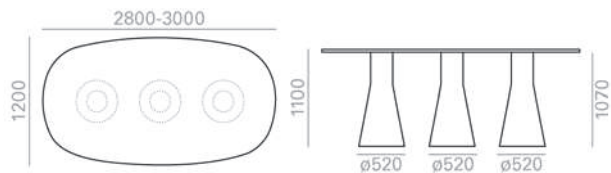

Preiszuschlag für Untergestell in Hochglanzlackierung..
Upcharge for bright lacquered finish bases.



Height adjustable glides up charged
Aufpreis für Höhenverstellbare Gleiter

Amount of sand: 150 kg. (3x15 kg.)
Füllgewicht aus Sand: 150 kg. (3x15 kg.)

Table height / Tischhöhe 1100													
Top measures Grösse der Tischplatte"	Table top / Tischplatten											Top & Base	
	Oak Eiche		s600	Lacquered Lackiert		Laminate Laminat		LaminateTP LaminatTP		Top Technical Stone 8		Low Iron Glass Optisch Glas	Cement Cement
	Ref.			Ref.		Ref.		Ref.		Ref.		Ref.	
2800x1200	ME9930		ME9932		ME9934		ME9936		ME9938		ME9940		ME9942
kg	149		149		149		149		149		181	149	
2 boxes/ kartons m3	2,27		2,27		2,27		2,27		5'81		5'81	2'27	
3000x1200	ME9931		ME9933		ME9935		ME9937		ME9939		ME9941		ME9943
kg	155		155		155		155		155		189	155	
2 boxes/ kartons m3	2,32		2,32		2,32		2,32		6'09		6'09	2'32	

Table height / Tischhöhe 1100												
Top measures Grösse der Tischplatte"	Table top / Tischplatten											
	Linoleum Linoleum		Ultra-matte Ultra-mat		Ultra-matteTP Ultra-matTP							
	Ref.		Ref.		Ref.							
2800x1200	ME9944		ME9946		ME9948							
kg	149		149		149							
2 boxes/ kartons m3	2,27		2,27		2,27							
3000x1200	ME9945		ME9947		ME9949							
kg	155		155		155							
2 boxes/ kartons m3	2,32		2,32		2,32							

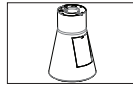
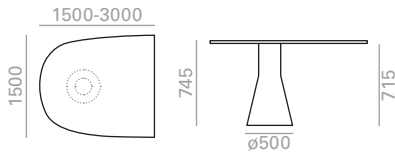

Access panel for wiring up charge.
Aufpreis für Zugangsklappe für die Verkabelung.



Preiszuschlag für Untergestell in Hochglanzlackierung..
Upcharge for bright lacquered finish bases.



Height adjustable glides up charged
Aufpreis für Höhenverstellbare Gleiter

Table height / Tischhöhe 745															
Top measures Grösse der Tischplatte"	Table top / Tischplatten												Top & Base		
	Oak Eiche		s600	Lacquered Lackiert		Laminate Laminat		Laminate TP LaminatTP		*Top Technical Stone 8		Low Iron Glass Optisch Glas		Cement Cement	
	Ref.			Ref.		Ref.		Ref.		Ref.		Ref.		Ref.	
1500x1500	ME7890			ME7894		ME7898		ME7902		ME7910		ME7906		ME7914	
kg	110		110		110		110		110		133		110		
2 boxes/ kartons m3	0,73		0,73		0,73		0,73		3'18		2'19		0'73		
2000x1500	ME7891			ME7895		ME7899		ME7903		ME7911		ME7907		ME7915	
kg	129		129		129		129		129		159		129		
2 boxes/ kartons m3	0,86		0,86		0,86		0,86		4'03		1'41		0'86		
2500x1500	ME7892			ME7896		ME7900		ME7904		ME7912		ME7908		ME7916	
kg	147		147		147		147		147		182		147		
2 boxes/ kartons m3	1,14		1		1		1		4'88		4'88		1		
3000x1500	ME7893			ME7897		ME7901		ME7905		ME7913		ME7909		ME7917	
kg	164		164		164		164		164		207		164		
2 boxes/ kartons m3	1,14		1,14		1,14		1,14		5'73		5'73		1'14		

*Maximum width 1440 mm Ancho máximo 1440 mm

Table height / Tischhöhe 745														
Top measures Grösse der Tischplatte"	Table top / Tischplatten													
	Linoleum Linoleum		Ultra-matte Ultra-mat		Ultra-matte TP Ultra-mat TP									
	Ref.		Ref.		Ref.									
1500x1500	ME7918		ME7922		ME7926									
kg	110		110		110									
2 boxes/ kartons m3	0,86		0,73		0,73									
2000x1500	ME7919		ME7923		ME7927									
kg	129		129		129									
2 boxes/ kartons m3	0,86		0,86		0,86									
2500x1500	ME7920		ME7924		ME7928									
kg	147		147		147									
2 boxes/ kartons m3	1,04		1,04		1,04									
3000x1500	ME7921		ME7925		ME7929									
kg	164		164		164									
2 boxes/ kartons m3	1,14		1,14		1,14									

Amount of sand: 50 kg. (2x25 kg.) Füllgewicht aus Sand: 50 kg. (2x25 kg.)

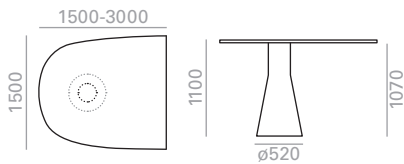

Preiszuschlag für Untergestell in Hochglanzlackierung..
Upcharge for bright lacquered finish bases.



Height adjustable glides up charged
Aufpreis für Höhenverstellbare Gleiter

Table height / Tischhöhe 1100															
Top measures Grösse der Tischplatte"	Table top / Tischplatten												Top & Base		
	Oak Eiche		s600	Lacquered Lackiert		Laminate Laminat		Laminate TP Laminat TP		*Top Technical Stone 8		Low Iron Glass Optisch Glas		Cement Cement	
	Ref.			Ref.		Ref.		Ref.		Ref.		Ref.		Ref.	
1500x1500	ME7930			ME7934		ME7938		ME7942		ME7950		ME7946		ME7954	
kg	121		121		121		121		121		143		121		
2 boxes/ kartons m3	0,87		0,87		0,87		0,87		3'32		1'3		0'87		
2000x1500	ME7931			ME7935		ME7939		ME7943		ME7951		ME7947		ME7955	
kg	140		140		140		140		140		169		140		
2 boxes/ kartons m3	1,01		1,01		1,01		1,01		4'17		1'55		1'01		
2500x1500	ME7932			ME7936		ME7940		ME7944		ME7952		ME7948		ME7956	
kg	157		157		157		157		157		192		157		
2 boxes/ kartons m3	1,15		1,15		1,15		1,15		5'02		5'02		1'15		
3000x1500	ME7933			ME7937		ME7941		ME7945		ME7953		ME7949		ME7957	
kg	174		174		174		174		174		217		174		
2 boxes/ kartons m3	1,28		1,28		1,28		1,28		5'87		5'87		1'28		

*Maximum width 1440 mm Ancho máximo 1440 mm

Amount of sand: 50 kg. (2x25 kg.) Füllgewicht aus Sand: 50 kg. (2x25 kg.)

Table height / Tischhöhe 1100														
Top measures Grösse der Tischplatte"	Table top / Tischplatten													
	Linoleum Linoleum		Ultra-matte Ultra-mat		Ultra-matte TP Ultra-mat TP									
	Ref.		Ref.		Ref.									
1500x1500	ME7958		ME7962		ME7966									
kg	121		121		121									
2 boxes/ kartons m3	0,87		0,87		0,87									
2000x1500	ME7959		ME7963		ME7967									
kg	140		140		140									
2 boxes/ kartons m3	1,01		1,01		1,01									
2500x1500	ME7960		ME7964		ME7968									
kg	157		157		157									
2 boxes/ kartons m3	1,15		1,15		1,15									
3000x1500	ME7961		ME7965		ME7969									
kg	174		174		174									
2 boxes/ kartons m3	1,28		1,28		1,28									

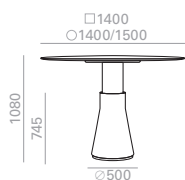

Preiszuschlag für
Untergestell in
Hochglanzlackierung..
Upcharge for bright
lacquered finish bases.

Amount of sand: 50 kg. Füllgewicht aus Sand: 50 kg.

Table height / Tischhöhe 745									
Top measures Grösse der Tischplatte"	Table top / Tischplatten						Top & Base		
	Oak Eiche		s600	Lacquered Lackiert		Low Iron Glass Optisch Glas		Cement Ziment	
	Ref.			Ref.		Ref.		Ref.	
1400X1400	ME4950			ME4951		ME4952		ME4953	
kg	125			125			125		125
2 boxes/ kartons m3	0,59			0,59			0,59		0'59
ø1400	ME4954			ME4955		ME4956		ME4957	
kg	125			125			125		125
2 boxes/ kartons m3	0,59			0,59			0,59		0'59
ø1500	ME4958			ME4959		ME4960		ME4961	
kg	127			127			127		127
2 boxes/ kartons m3	0,62			0,62			0,62		0'62
ellipse/ ellipse 1400X1400	ME4962			ME4963		ME4964		ME4965	
kg	125			125			125		125
2 boxes/ kartons m3	0,59			0,59			0,59		0'59

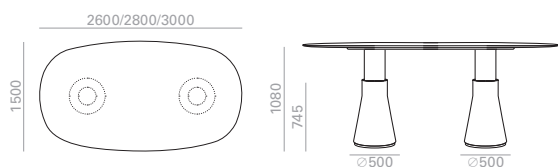

Preiszuschlag für
Untergestell in
Hochglanzlackierung..
Upcharge for bright
lacquered finish bases.

Amount of sand: 100 kg. (2x50kg.) Füll-
gewicht aus Sand: 100 kg. (2x50kg.)

Table height / Tischhöhe 745															
Top measures Grösse der Tischplatte"	Table top / Tischplatten												Top & Base		
	Oak Eiche		s600	Lacquered Lackiert		Laminate Laminat		Laminate TP LaminatTp		*Top Technical Stone 8		Low Iron Glass Optisch Glas		Cement Ziment	
	Ref.			Ref.		Ref.		Ref.		Ref.		Ref.		Ref.	
2600x1500	ME4966			ME4967		ME4968		ME4969		ME4970		ME4971		ME4972	
kg	157		151		151		151		151		151		151		
2 boxes/ kartons m3	1		1		1		1		1		1		1		
2800x1500	ME4973			ME4974		ME4975		ME4976		ME4977		ME4978		ME4979	
kg	157		157		157		157		157		157		157		
2 boxes/ kartons m3	1,04		1,04		1,04		1,04		1'04		1'04		1'04		
3000x1500	ME4980			ME4981		ME4982		ME4983		ME4984		ME4985		ME4986	
kg	162		162		162		162		162		162		162		
2 boxes/ kartons m3	1,09		1,09		1,09		1,09		1'09		1'09		1'09		

*Maximum width 1440 mm Ancho máximo 1440 mm

Table height / Tischhöhe 745														
Top measures Grösse der Tischplatte"	Table top / Tischplatten													
	Linoleum Linoleum		Ultra-matte Ultra-matt		Ultra-matte TP Ultra-matt TP									
	Ref.		Ref.		Ref.									
2600x1500	ME4987			ME4988		ME4989								
kg	151		151		151									
2 boxes/ kartons m3	1		1		1									
2800x1500	ME4990			ME4991		ME4992								
kg	157		157		157									
2 boxes/ kartons m3	1,04		1,04		1,04									
3000x1500	ME4993			ME4994		ME4995								
kg	162		162		162									
2 boxes/ kartons m3	1,09		1,09		1,09									

PS-IN SURFACE



**PS0735
PS0737 UK**



**PS0736
PS0738 UK**



PS0804

PS-QI



PS0714

**Preinstalled (optional) Vor-Verkabelung
IN0006**

PS-UNDERTOP



PS0715



**PS0787
PS0763 UK**



**PS0789
PS0760 UK**



**PS0788
PS0759 UK**



**PS0790
PS0761 UK**

PS-INTREGATED

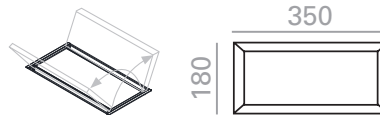

**PS0710
PS0712 UK**

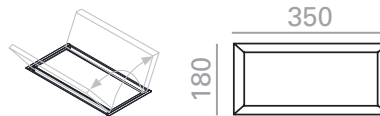

**PS0720
PS0722 UK**

SOCKETTOWER ANSCHLUSSSYSTEM

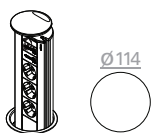

**PS0795
PS0797 UK**

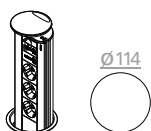

**PS0796
PS0798 UK**

IN-SURFACE POWER BOXES POWER BOX IN DER TISCHPLATTE

Aluminum power box mounted in the table top with a folding protective lid. Available for any Reverse model. It is served in anodized silver, black or white color, for other finishing, contact the Customer Department. There are two power system sizes available and data slots can be customized according to the below diagram.

Einbaumodul aus Aluminium, integriert in der Oberfläche der Tischplatte, mit Klappdeckel, verfügbar für alle Versionen der Kollektion Reverse. Ausführung in silber eloxiert, schwarz oder weiss, für andere Ausführungen setzen Sie sich mit unserer Verkaufsabteilung in Verbindung. Verfügbar in zwei verschiedene Kastengrößen und mit konfigurierbare Anschlussmöglichkeiten.

PS0735 PS0737 (UK)



PS0736 PS0738 (UK)

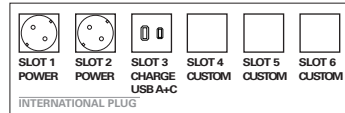
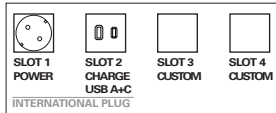

CHOOSE DATA PORT FOR DATA CUSTOM PORT SLOTS

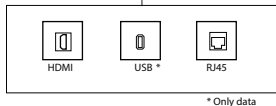

OPTIONAL PREINSTALLED WIRING VOR-VERKABELUNG

IN0006

Preinstalled wiring consists in the addition of the necessary mechanisms to integrate power systems in the table, so that wiring is hidden until the way out in the floor. Necessary grommet are included and 3m cable (from the power system). For other cable dimensions contact the Customer Department. Tables with only one base are exempt of this charge, for the rest of tables ask the Customer Department.

Die Vor-Verkabelung besteht aus den notwendigen Befestigungsmechanismen um das System in den Tisch zu kaschieren, so dass die Kabeln bis zum Schluss versteckt werden. Es sind die erforderlichen Tüllen und 3-Meter-Kabel enthalten. Für andere Kabellängen setzen Sie sich mit unserer Verkaufsabteilung in Verbindung.

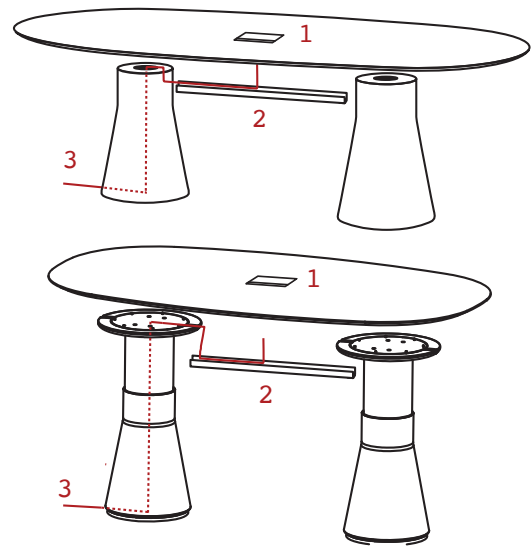

1 POWER BOXES DISTRIBUTION POWER BOX VERTEILUNG

In tables with only one Reverse base power box can't be centered with the base. In tables with more than one base, by default power box is placed in the center of the table and in lengthwise direction. If more than one power box is installed, inform the Customer Department about the desired position.

Bei Tischen mit einem einzigen Untergestell wird die Power-Box exzentrisch positioniert. Bei Tischen mit mehr als einem Untergestell wird die Power-Box in der Mitte des Tisches und in Längsrichtung positioniert. Wenn mehr als eine Power-Box bestellt wird, muss die gewünschte Position mitgeteilt.

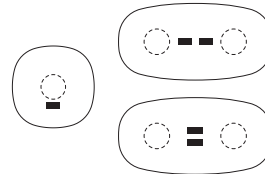

2 WIRING MANAGEMENT KABEL-VERWALTUNG

Wire pass through an aluminum grommet keeping it hidden. By default color is silver, for other finishings ask the Customer Department.

Das Kabel geht durch eine Aluminium-Tülle. Die Standardausführung ist silber, für weitere Ausführungen setzen Sie sich mit unserer Verkaufsabteilung in Verbindung.

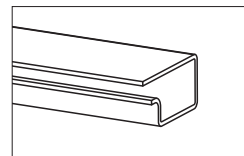

3 CABLE WAY OUT AUSGANG DES KABELS

The cable way out can be performed directly from the power system or thru a canal in the base bottom, so that is hidden until it gets to the floor. Der Kabelausgang wird direkt aus dem System selbst gemacht, so dass das Kabel bis zum Boden versteckt bleibt.

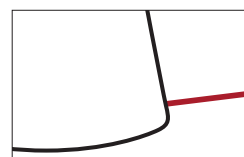

IN-SURFACE POWER BOXES POWER BOX IN DER TISCHPLATTE

It is a data dynamo with 2 amp dual charging USB. Available in two finishes: black or white.

PS0804

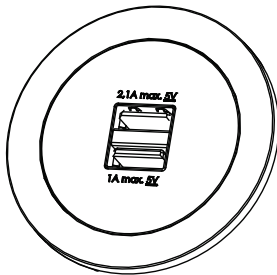

OPTIONAL PREINSTALLED WIRING VOR-VERKABELUNG

IN0006

Preinstalled wiring consists in the addition of the necessary mechanisms to integrate power systems in the table, so that wiring is hidden until the way out in the floor. Necessary grommet are included and 3m cable (from the power system). For other cable dimensions contact the Sales Department. For each wire Reverse base, you must ask for one IN0006 to the Customer Department.

Die Vor-Verkabelung besteht aus den notwendigen Befestigungsmechanismen um das System in den Tisch zu kaschieren, so dass die Kabeln bis zum Schluss versteckt werden. Es sind die erforderlichen Tüllen und 3 -MeterKabel enthalten. Für jedes Untergestell ist ein IN0006 notwendig.

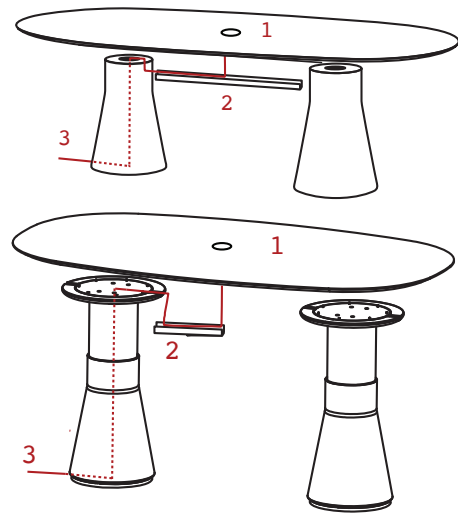

1 POWER BOXES DISTRIBUTION POWER BOX VERTEILUNG

In tables with only one Reverse base power box can't be centered with the base. In tables with more than one base, by default power box is placed in the center of the table and in lengthwise direction. If more than one power box is installed, inform the Customer Department about the desired position.

Bei Tischen mit mehr als einem Untergestell wird die Power-Box in der Mitte des Tisches und in Längsrichtung positioniert. Wenn mehr als eine Power-Box bestellt wird, muss die gewünschte Position mitgeteilt.

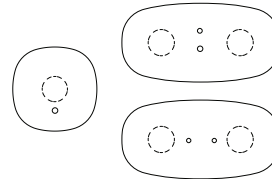

2 WIRING MANAGEMENT KABEL-VERWALTUNG

Wire pass through an aluminum grommet keeping it hidden. By default color is silver, for other finishings ask the Customer Department.

Das Kabel geht durch eine Aluminium-Tülle. Die Standardausführung ist silber, für weitere Ausführungen setzen Sie sich mit unserer Verkaufsabteilung in Verbindung.

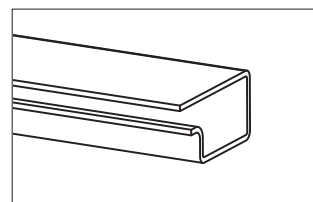

3 CABLE WAY OUT AUSGANG DES KABELS

The cable way out can be performed directly from the power system or thru a canal in the base bottom, so that is hidden until it gets to the floor. Der Kabelausgang wird direkt aus dem System selbst gemacht, so dass das Kabel bis zum Boden versteckt bleibt.

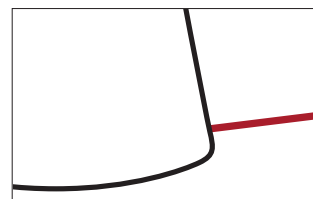

QI CHARGING POWER BOXES POWER BOX QI LADEN

The inductive charging station, allows maximum larger contact surface. Available in two finish: black or white.

PS0714

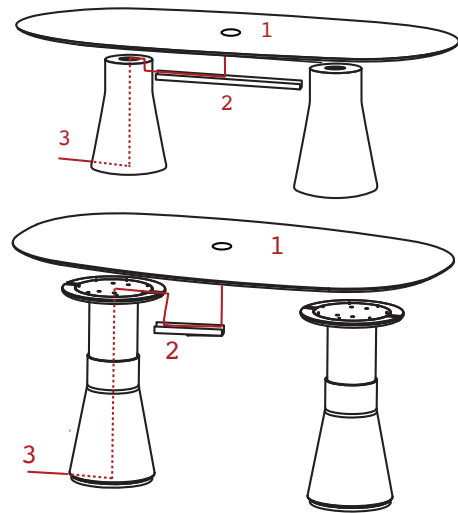
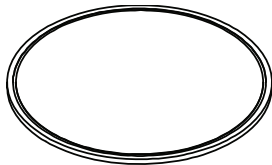

1 POWER BOXES DISTRIBUTION POWER BOX VERTEILUNG

In tables with only one Reverse base power box can't be centered with the base. In tables with more than one base, by default power box is placed in the center of the table and in lengthwise direction. If more than one power box is installed, inform the Customer Department about the desired position.

Bei Tischen mit einem einzigen Untergestell wird die Power-Box exzentrisch positioniert. Bei Tischen mit mehr als einem Untergestell wird die Power-Box in der Mitte des Tisches und in Längsrichtung positioniert. Wenn mehr als eine Power-Box bestellt wird, muss die gewünschte Position mitgeteilt.

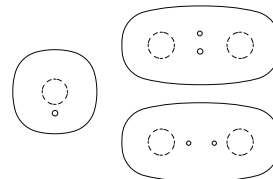

2 WIRING MANAGEMENT KABEL-VERWALTUNG

Wire pass through an aluminum grommet keeping it hidden. By default color is silver, for other finishings ask the Customer Department.

Das Kabel geht durch eine Aluminium-Tülle. Die Standardausführung ist silber, für weitere Ausführungen setzen Sie sich mit unserer Verkaufsabteilung in Verbindung.

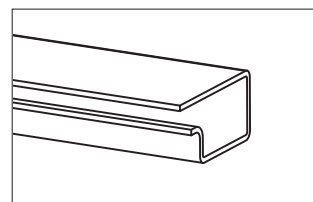

OPTIONAL PREINSTALLED WIRING VOR-VERKABELUNG

IN0006

Preinstalled wiring consists in the addition of the necessary mechanisms to integrate power systems in the table, so that wiring is hidden until the way out in the floor. Necessary grommet are included and 3m cable (from the power system). For other cable dimensions contact the Sales Department. For each wire Reverse base, you must ask for one IN0006 to the Customer Department.

Die Vor-Verkabelung besteht aus den notwendigen Befestigungsmechanismen um das System in den Tisch zu kaschieren, so dass die Kabeln bis zum Schluss versteckt werden. Es sind die erforderlichen Tüllen und 3 -MeterKabel enthalten. Für jedes Untergestell ist ein IN0006 notwendig.

3 CABLE WAY OUT AUSGANG DES KABELS

The cable way out can be performed directly from the power system or thru a canal in the base bottom, so that is hidden until it gets to the floor.

Der Kabelausgang wird direkt aus dem System selbst gemacht, so dass das Kabel bis zum Boden versteckt bleibt.

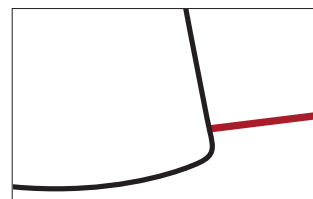

INTEGRATED POWER BOXES POWER BOX INTEGRIERT

The black finish is integrated with the top. Its opening is towards both sides.

Das schwarze Finish ist mit der Oberseite integriert. Seine Öffnung ist nach beiden Seiten gerichtet.

PS0710
PS0712 (UK)

PS0720
PS0722 (UK)

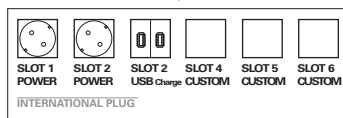
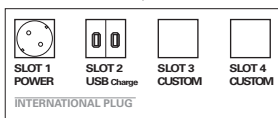
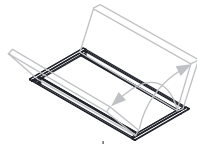
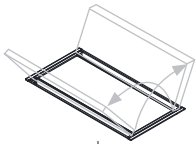

CHOOSE DATA PORT FOR DATA CUSTOM PORT SLOTS

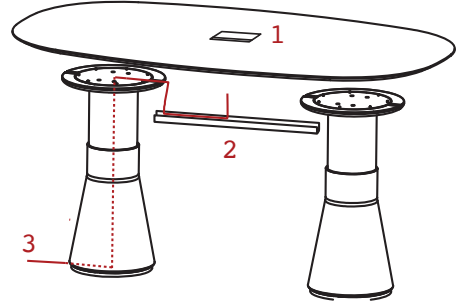
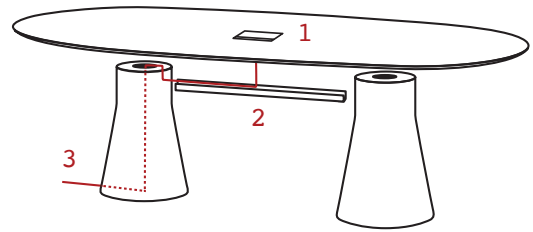
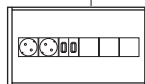
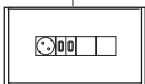
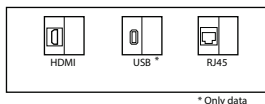

1 POWER BOXES DISTRIBUTION POWER BOX VERTEILUNG

In tables with only one Reverse base power box can't be centered with the base. In tables with more than one base, by default power box is placed in the center of the table and in lengthwise direction. If more than one power box is installed, inform the Customer Department about the desired position.

Bei Tischen mit einem einzigen Untergestell wird die Power-Box exzentrisch positioniert. Bei Tischen mit mehr als einem Untergestell wird die Power-Box in der Mitte des Tisches und in Längsrichtung positioniert. Wenn mehr als eine Power-Box bestellt wird, muss die gewünschte Position mitgeteilt.

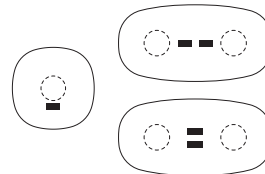

2 WIRING MANAGEMENT KABEL-VERWALTUNG

Wire pass through an aluminum grommet keeping it hidden. By default color is silver, for other finishings ask the Customer Department.

Das Kabel geht durch eine Aluminium-Tülle. Die Standardausführung ist silber, für weitere Ausführungen setzen Sie sich mit unserer Verkaufsabteilung in Verbindung.

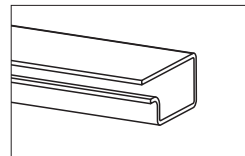

OPTIONAL PREINSTALLED WIRING VOR-VERKABELUNG

IN0006

Preinstalled wiring consists in the addition of the necessary mechanisms to integrate power systems in the table, so that wiring is hidden until the way out in the floor. Necessary grommet are included and 3m cable (from the power system). For other cable dimensions contact the Sales Department. For each wire Reverse base, you must ask for one IN0006 to the Customer Department.

Die Vor-Verkabelung besteht aus den notwendigen Befestigungsmechanismen um das System in den Tisch zu kaschieren, so dass die Kabeln bis zum Schluss versteckt werden. Es sind die erforderlichen Tüllen und 3-Meter-Kabel enthalten. Für jedes Untergestell ist ein IN0006 notwendig.

3 CABLE WAY OUT AUSGANG DES KABELS

The cable way out can be performed directly from the power system or thru a canal in the base bottom, so that is hidden until it gets to the floor. Der Kabelausgang wird direkt aus dem System selbst gemacht, so dass das Kabel bis zum Boden versteckt bleibt.

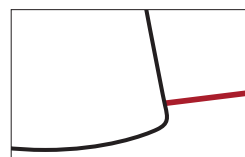

UNDER-TOP POWER BOXES POWER BOX UNTER DER TISCHPLATTE

Power box mounted under the table top. Available in black or white color, for other finishing, contact the Customer Department. There are two power system sizes available and data slots can be customized according to the below diagram.

PS0787 PS0763 (UK)

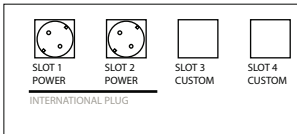
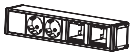

PS0788 PS0759 (UK)

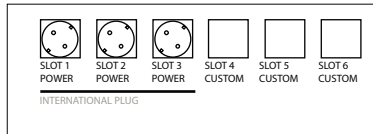

CHOOSE DATA PORT FOR DATA CUSTOM PORT SLOTS

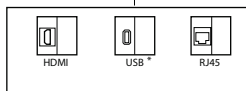

* Only data

PS0789 PS0760 (UK)

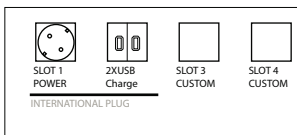

PS0790 PS0761 (UK)

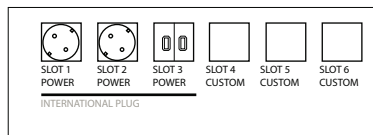

CHOOSE DATA PORT FOR DATA CUSTOM PORT SLOTS

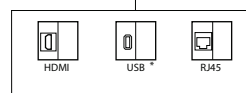

* Only data

OPTIONAL PREINSTALLED WIRING VOR-VERKABELUNG

IN0006

Preinstalled wiring consists in the addition of the necessary mechanisms to integrate power systems in the table, so that wiring is hidden until the way out in the floor. Necessary grommet are included and 3m cable (from the power system). For other cable dimensions contact the Sales Department. For each wire Reverse base, you must ask for one IN0006 to the Customer Department.

Die Vor-Verkabelung besteht aus den notwendigen Befestigungsmechanismen um das System in den Tisch zu kaschieren, so dass die Kabeln bis zum Schluss versteckt werden. Es sind die erforderlichen Tüllen und 3-Meter-Kabel enthalten. Für jedes Untergestell ist ein IN0006 notwendig.

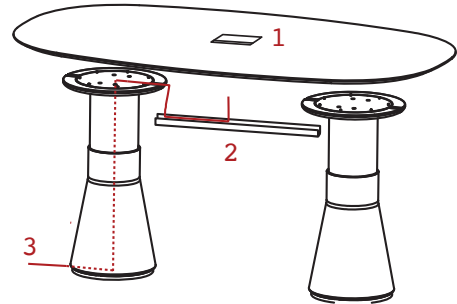
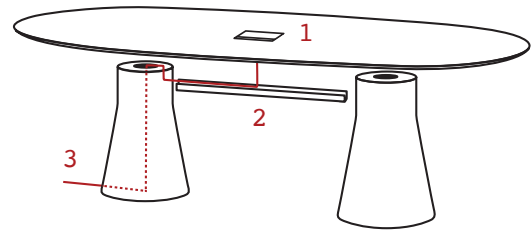

1 POWER BOXES DISTRIBUTION POWER BOX VERTEILUNG

In tables with only one Reverse base power box can't be centered with the base. In tables with more than one base, by default power box is placed in the center of the table and in lengthwise direction. If more than one power box is installed, inform the Customer Department about the desired position.

Bei Tischen mit einem einzigen Untergestell wird die Power-Box exzentrisch positioniert. Bei Tischen mit mehr als einem Untergestell wird die Power-Box in der Mitte des Tisches und in Längsrichtung positioniert. Wenn mehr als eine Power-Box bestellt wird, muss die gewünschte Position mitgeteilt.

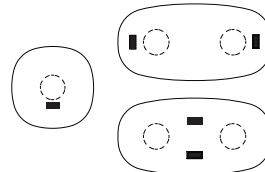

2 WIRING MANAGEMENT KABEL-VERWALTUNG

Wire pass through an aluminum grommet keeping it hidden. By default color is silver, for other finishings ask the Customer Department.

Das Kabel geht durch eine Aluminium-Tülle. Die Standardausführung ist silber, für weitere Ausführungen setzen Sie sich mit unserer Verkaufsabteilung in Verbindung.

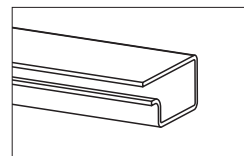

3 CABLE WAY OUT AUSGANG DES KABELS

The cable way out can be performed directly from the power system or thru a canal in the base bottom, so that is hidden until it gets to the floor.

Der Kabelausgang wird direkt aus dem System selbst gemacht, so dass das Kabel bis zum Boden versteckt bleibt.

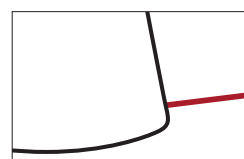

UNDER-TOP POWER BOXES POWER BOX UNTER DER TISCHPLATTE

Under table top USB charging system Ps composed of 2 USB charging, black or white.

PS0715

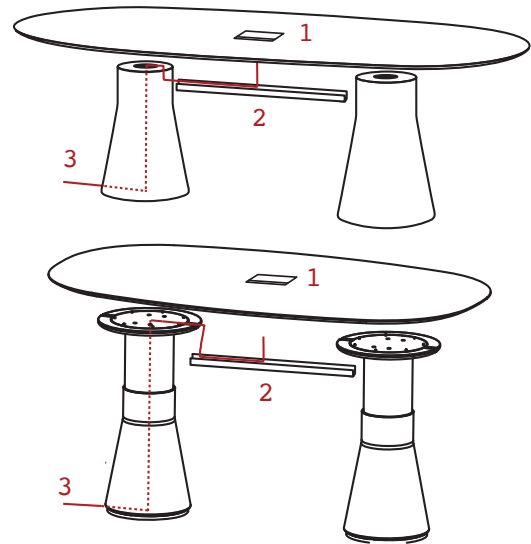
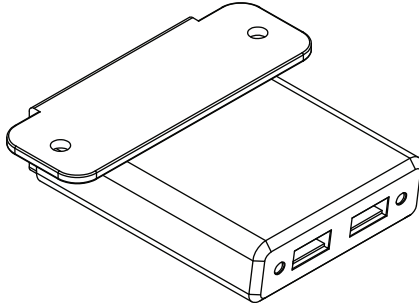

1 POWER BOXES DISTRIBUTION POWER BOX VERTEILUNG

In tables with only one Reverse base power box can't be centered with the base. In tables with more than one base, by default power box is placed in the center of the table and in lengthwise direction. If more than one power box is installed, inform the Customer Department about the desired position.

Bei Tischen mit einem einzigen Untergestell wird die Power-Box exzentrisch positioniert. Bei Tischen mit mehr als einem Untergestell wird die Power-Box in der Mitte des Tisches und in Längsrichtung positioniert. Wenn mehr als eine Power-Box bestellt wird, muss die gewünschte Position mitgeteilt.

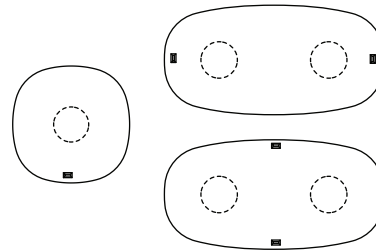

2 WIRING MANAGEMENT KABEL-VERWALTUNG

Wire pass through an aluminum grommet keeping it hidden. By default color is silver, for other finishings ask the Customer Department.

Das Kabel geht durch eine Aluminium-Tülle. Die Standardausführung ist silber, für weitere Ausführungen setzen Sie sich mit unserer Verkaufsabteilung in Verbindung.

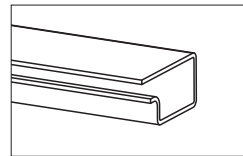

OPTIONAL PREINSTALLED WIRING VOR-VERKABELUNG

IN0006

Preinstalled wiring consists in the addition of the necessary mechanisms to integrate power systems in the table, so that wiring is hidden until the way out in the floor. Necessary grommet are included and 3m cable (from the power system). For other cable dimensions contact the Sales Department. For each wire Reverse base, you must ask for one IN0006 to the Customer Department.

Die Vor-Verkabelung besteht aus den notwendigen Befestigungsmechanismen um das System in den Tisch zu kaschieren, so dass die Kabeln bis zum Schluss versteckt werden. Es sind die erforderlichen Tüllen und 3 -MeterKabel enthalten. Für jedes Untergestell ist ein IN0006 notwendig.

3 CABLE WAY OUT AUSGANG DES KABELS

The cable way out can be performed directly from the power system or thru a canal in the base bottom, so that is hidden until it gets to the floor.

Der Kabelausgang wird direkt aus dem System selbst gemacht, so dass das Kabel bis zum Boden versteckt bleibt.

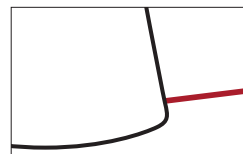

IN-SURFACE SOCKET POWERS ANSCHLUSSSYSTEM IN DER TISCHPLATTE

Socket tower mounted in the table top. The hidden system automatically rises with a slight push. Valid for Reverse tables with bases Reverse 38, 50 and 60. Available in silver, white or black color, for for other finishing, contact the Customer Department.

Anschlussystem mit der Tischplattenoberfläche integriert. Das versteckte elektrische System steigt automatisch wenn man drückt. Erhältlich für Untergestelle Reverse 38, 50 und 60. Es wird in der Ausführung silber, weiss oder schwarz. Für weitere Ausführungen, setzen Sie sich mit unserer Verkaufsabteilung in Verbindung.

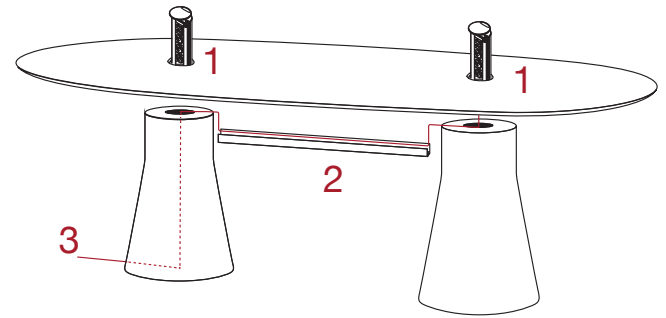

PS0795 PS0797 (UK)

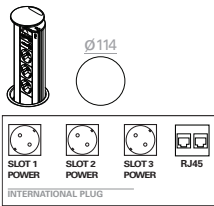

PS0796 PS0798 (UK)

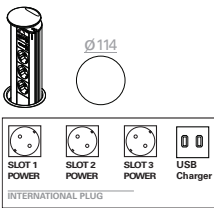

1 POWER BOXES DISTRIBUTION POWER BOX VERTEILUNG

In tables with only one Reverse base power box can't be centered with the base. In tables with more than one base, by default power box is placed in the center of the table and in lengthwise direction. If more than one power box is installed, inform the Customer Department about the desired position.

Bei Tischen mit mehr als einem Untergestell wird die Power-Box in der Mitte des Tisches und in Längsrichtung positioniert. Wenn mehr als eine Power-Box bestellt wird, muss die gewünschte Position mitgeteilt.



2 WIRING MANAGEMENT KABEL-VERWALTUNG

Wire pass through an aluminum grommet keeping it hidden. By default color is silver, for other finishings ask the Customer Department.

Das Kabel geht durch eine Aluminium-Tülle. Die Standardausführung ist silber, für weitere Ausführungen setzen Sie sich mit unserer Verkaufsabteilung in Verbindung.

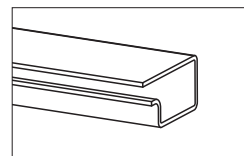

OPTIONAL PREINSTALLED WIRING VOR-VERKABELUNG

IN0006

Preinstalled wiring consists in the addition of the necessary mechanisms to integrate power systems in the table, so that wiring is hidden until the way out in the floor. Necessary grommet are included and 3m cable (from the power system). For other cable dimensions contact the Sales Department. For each wire Reverse base, you must ask for one IN0006 to the Customer Department.

Die Vor-Verkabelung besteht aus den notwendigen Befestigungsmechanismen um das System in den Tisch zu kaschieren, so dass die Kabeln bis zum Schluss versteckt werden. Es sind die erforderlichen Tüllen und 3 -MeterKabel enthalten. Für jedes Untergestell ist ein IN0006 notwendig.

3 CABLE WAY OUT AUSGANG DES KABELS

The cable way out can be performed directly from the power system or thru a canal in the base bottom, so that is hidden until it gets to the floor. Der Kabelausgang wird direkt aus dem System selbst gemacht, so dass das Kabel bis zum Boden versteckt bleibt.

