

Description
Beschreibung

Wooden sideboards available in different sizes and finishes. Base with steel legs and black finish, with the option of glossy finish. This collection, in addition to the door and drawer modules, includes an open module with shelf in smoked glass finish.

Holz Sideboards in verschiedenen Größen und Ausführungen erhältlich. Gestell mit Stahlbeinen und schwarzem Finish, mit einer glänzenden Finish-Option. Diese Kollektion umfasst neben den Tür- und Schubladenmodulen ein offenes Modul mit Smoked Glass.

Wood finish Oak
Holzausführungen
Eiche



Premium finish and wood lacquers
Premium
Ausführungen und
Holzlacke



Wood finish Walnut
Holzausführungen
Nussbaum

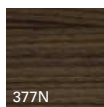

Technical Stone 8
finish

Technical Stone 8
ausführungen

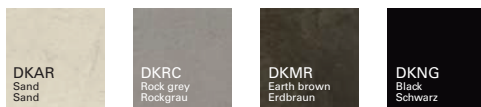

Glass finish

Glasausführungen

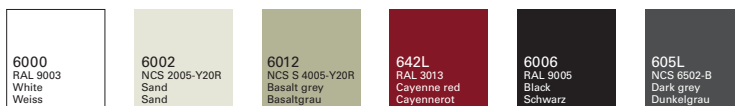

M1 marble finish

M1 Marmor-
Ausführung

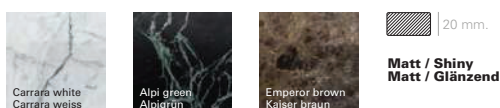

M2 marble finish

M2 Marmor-
Ausführung

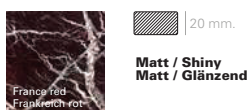

M3 marble finish

M3 Marmor-
Ausführung



Intellectual property Geistiges Eigentum

All our collections are protected by international industrial design registries, designs patents, copyrights and intellectual Property laws. Unauthorized use of AW International Property is a criminal offence and can lead to prosecution.
Alle unsere Kollektionen sind durch internationale Industrie-Design Register, Design Patente, Urheberrecht und geistiges Eigentum rechtlich geschützt. Die unbefugte Nutzung des internationalen Eigentums von AW ist eine Straftat und kann zur Strafverfolgung führen.



CONFIGURATION DIAGRAM
KONFIGURATIONSDIAGRAMM

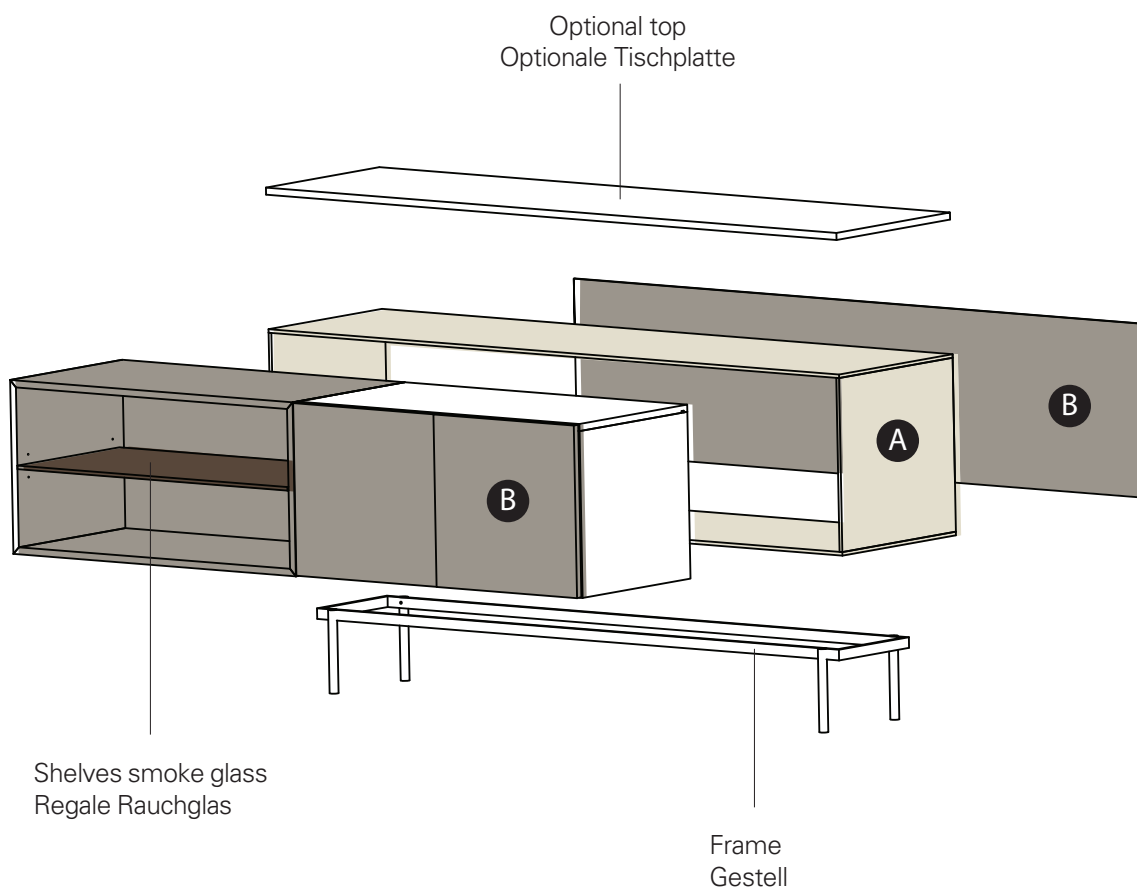

- A** Exterior material / Aussenmaterial
- B** Front and back material / Vorder- und Rückenmaterial

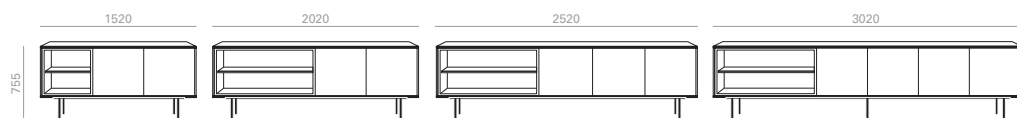

Column height / Höhe der Säule									
Top measures Größe der Tischplatte	Exterior material Außenmaterial			Table top / Tischplatten					
				Oak Eiche		Walnut Nussbaum		Lacquered Lackiert	
				Ref.		Ref.		Ref.	
1520x530x755	Oak Eiche	S600		AP04800		AP04801		AP04802	
kg			148'9		148'9		148'9		
3 boxes / kartons			1,09		1,09		1,09		
2020x530x755	Oak Eiche	S600		AP04836		AP04837		AP04838	
kg			166'5		166'5		166'5		
5 boxes / kartons			1,25		1,25		1,25		
2520x530x755	Oak Eiche	S600		AP04872		AP04873		AP04874	
kg			181'7		181'7		181'7		
5 boxes / kartons			1,57		1,57		1,57		
3020x530x755	Oak Eiche	S600		AP04908		AP04909		AP04910	
kg			208'9		208'9		208'9		
6 boxes / kartons			1,82		1,82		1,82		
1520x530x755	Walnut Nussbaum			AP04803		AP04804		AP04805	
kg			148'9		148'9		148'9		
3 boxes / kartons			1,09		1,09		1,09		
2020x530x755	Walnut Nussbaum			AP04839		AP04840		AP04841	
kg			166'5		166'5		166'5		
5 boxes / kartons			1,25		1,25		1,25		
2520x530x755	Walnut Nussbaum			AP04875		AP04876		AP04877	
kg			181'7		181'7		181'7		
5 boxes / kartons			1,57		1,57		1,57		
3020x530x755	Walnut Nussbaum			AP04911		AP04912		AP04913	
kg			208'9		208'9		208'9		
6 boxes / kartons			1,82		1,82		1,82		
1520x530x755	Lacquered Lackiert			AP04806		AP04807		AP04808	
kg			148'9		148'9		148'9		
3 boxes / kartons			1,09		1,09		1,09		
2020x530x755	Lacquered Lackiert			AP04842		AP04843		AP04844	
kg			166'5		166'5		166'5		
5 boxes / kartons			1,25		1,25		1,25		
2520x530x755	Lacquered Lackiert			AP04878		AP04879		AP04880	
kg			181'7		181'7		181'7		
5 boxes / kartons			1,57		1,57		1,57		
3020x530x755	Lacquered Lackiert			AP04914		AP04915		AP04916	
kg			208'9		208'9		208'9		
6 boxes / kartons			1,82		1,82		1,82		











Aufpreis für Glanzverchromt
Polished Chrome upcharge

Aufpreis für Glanzverchromt
Polished Chrome upcharge

Aufpreis für Glanzverchromt
Polished Chrome upcharge

Aufpreis für Glanzverchromt
Polished Chrome upcharge

Optional table tops /Sobres opcionales					
Top measures Medidas Sobres	***Technical Stone 8	***Low Iron Glass Optisch Glas	***Marble M1 Marmor M1	Marble M2 Marmor M2	Marble M3 Marmor M3
1520x530x755					
 kg					
 m3					
2020x530x755					
 kg					
 m3					
2520x530x755					
 kg					
 m3					
3020x530x755					
 kg					
 m3					

***Marble shiny
upcharge
Aufpreis für marmor
glänzend

CONFIGURATION DIAGRAM
KONFIGURATIONSDIAGRAMM

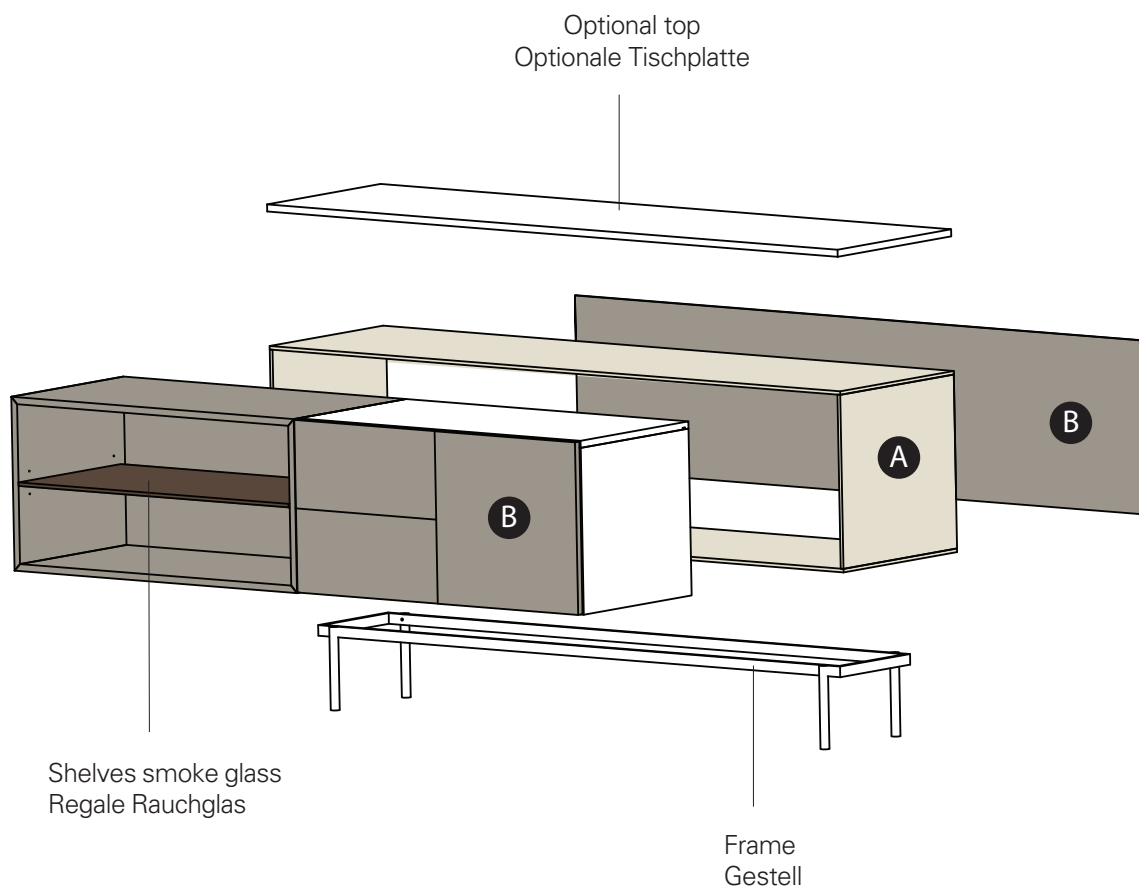

- A** Exterior material / Aussenmaterial
- B** Front and back material / Vorder- und Rückenmaterial

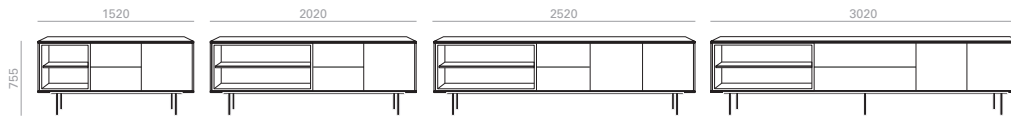

Column height / Höhe der Säule									
Top measures Größe der Tischplatte*	Exterior material Außenmaterial			Table top / Tischplatten					
				Oak Eiche		Walnut Nussbaum		Lacquered Lackiert	
	Ref.	Ref.	Ref.	Ref.	Ref.	Ref.	Ref.	Ref.	Ref.
1520x530x755	Oak Eiche	S600		AP04809		AP04810		AP04811	
	kg			148'9		148'9		148'9	
	3 boxes / kartons	m3		1,09		1,09		1,09	
2020x530x755	Oak Eiche	S600		AP04845		AP04846		AP04847	
	kg			166'5		166'5		166'5	
	5 boxes / kartons	m3		1,25		1,25		1,25	
2520x530x755	Oak Eiche	S600		AP04881		AP04882		AP04883	
	kg			181'7		181'7		181'7	
	5 boxes / kartons	m3		1,57		1,57		1,57	
3020x530x755	Oak Eiche	S600		AP04917		AP04918		AP04919	
	kg			208'9		208'9		208'9	
	6 boxes / kartons	m3		1,82		1,82		1,82	
1520x530x755	Walnut Nussbaum			AP04812		AP04813		AP04814	
	kg			148'9		148'9		148'9	
	3 boxes / kartons	m3		1,09		1,09		1,09	
2020x530x755	Walnut Nussbaum			AP04848		AP04849		AP04850	
	kg			166'5		166'5		166'5	
	5 boxes / kartons	m3		1,25		1,25		1,25	
2520x530x755	Walnut Nussbaum			AP04884		AP04885		AP04886	
	kg			181'7		181'7		181'7	
	5 boxes / kartons	m3		1,57		1,57		1,57	
3020x530x755	Walnut Nussbaum			AP04920		AP04921		AP04922	
	kg			208'9		208'9		208'9	
	6 boxes / kartons	m3		1,82		1,82		1,82	
1520x530x755	Lacquered Lackiert			AP04815		AP04816		AP04817	
	kg			148'9		148'9		148'9	
	3 boxes / kartons	m3		1,09		1,09		1,09	
2020x530x755	Lacquered Lackiert			AP04851		AP04852		AP04853	
	kg			166'5		166'5		166'5	
	5 boxes / kartons	m3		1,25		1,25		1,25	
2520x530x755	Lacquered Lackiert			AP04887		AP04888		AP04889	
	kg			181'7		181'7		181'7	
	5 boxes / kartons	m3		1,57		1,57		1,57	
3020x530x755	Lacquered Lackiert			AP04923		AP04924		AP04925	
	kg			208'9		208'9		208'9	
	6 boxes / kartons	m3		1,82		1,82		1,82	











Aufpreis für Glanzverchromt
Polished Chrome upcharge

Aufpreis für Glanzverchromt
Polished Chrome upcharge

Aufpreis für Glanzverchromt
Polished Chrome upcharge

Aufpreis für Glanzverchromt
Polished Chrome upcharge

Optional table tops /Sobres opcionales					
Top measures Medidas Sobres	***Technical Stone 8	***Low Iron Glass Optisch Glas	***Marble M1 Marmor M1	Marble M2 Marmor M2	Marble M3 Marmor M3
1520x530x755					
 kg					
 m3					
2020x530x755					
 kg					
 m3					
2520x530x755					
 kg					
 m3					
3020x530x755					
 kg					
 m3					

***Marble shiny
upcharge
Aufpreis für marmor
glänzend

CONFIGURATION DIAGRAM
KONFIGURATIONSDIAGRAMM

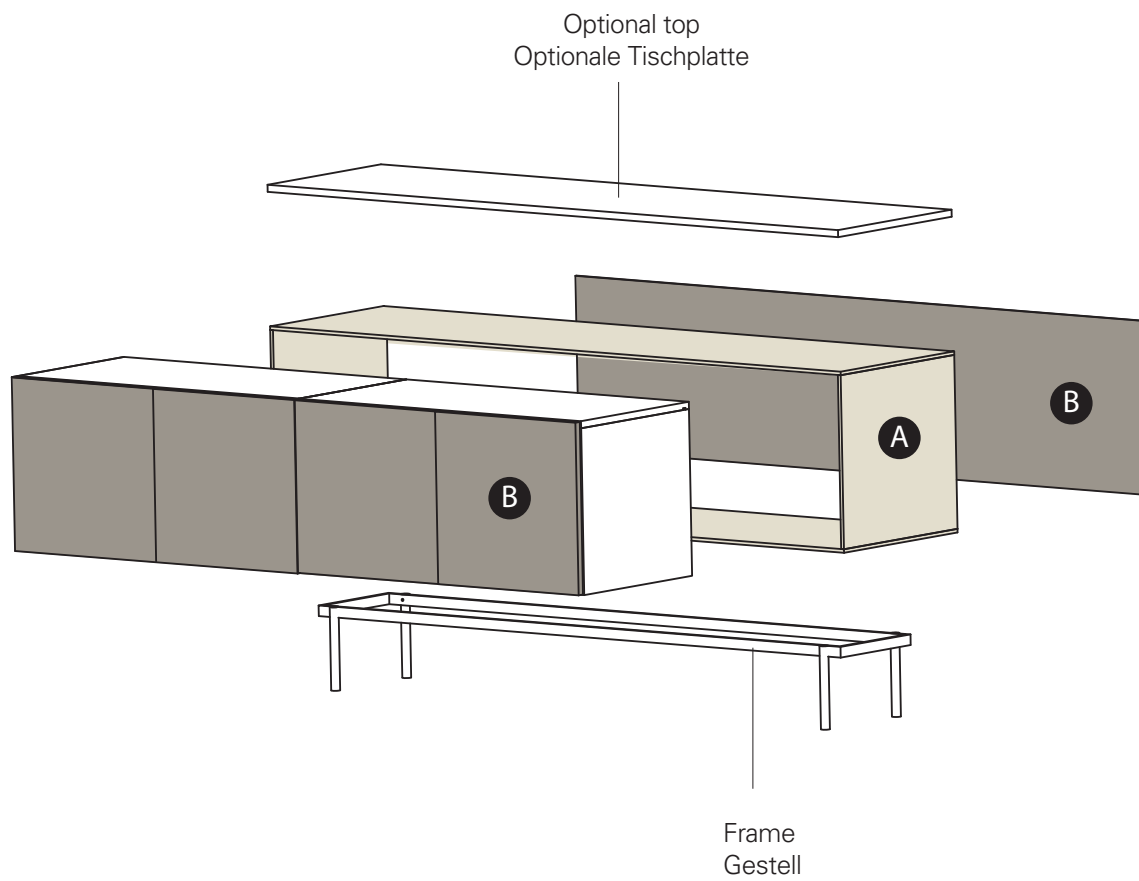

- A** Exterior material / Material exterior
- B** Front and back material / Material frontal y posterior



Column height / Höhe der Säule									
Top measures Größe der Tischplatte*	Exterior material Außenmaterial			Table top / Tischplatten					
				Oak Eiche		Walnut Nussbaum		Lacquered Lackiert	
				Ref.		Ref.		Ref.	
1520x530x755	Oak Eiche	S600		AP04818		AP04819		AP04820	
			kg	148'9		148'9		148'9	
2 boxes / kartons			m3	1,09		1,09		1,09	
2020x530x755	Oak Eiche	S600		AP04854		AP04855		AP04856	
			kg	166'5		166'5		166'5	
4 boxes / kartons			m3	1,25		1,25		1,25	
2520x530x755	Oak Eiche	S600		AP04890		AP04891		AP04892	
			kg	181'7		181'7		181'7	
4 boxes / kartons			m3	1,57		1,57		1,57	
3020x530x755	Oak Eiche	S600		AP04926		AP04927		AP04928	
			kg	208'9		208'9		208'9	
5 boxes / kartons			m3	1,82		1,82		1,82	
1520x530x755	Walnut Nussbaum			AP04821		AP04822		AP04823	
			kg	148'9		148'9		148'9	
2 boxes / kartons			m3	1,09		1,09		1,09	
2020x530x755	Walnut Nussbaum			AP04857		AP04858		AP04859	
			kg	166'5		166'5		166'5	
4 boxes / kartons			m3	1,25		1,25		1,25	
2520x530x755	Walnut Nussbaum			AP04893		AP04894		AP04895	
			kg	181'7		181'7		181'7	
4 boxes / kartons			m3	1,57		1,57		1,57	
3020x530x755	Walnut Nussbaum			AP04929		AP04930		AP04931	
			kg	208'9		208'9		208'9	
5 boxes / kartons			m3	1,82		1,82		1,82	
1520x530x755	Lacquered Lackiert			AP04824		AP04825		AP04826	
			kg	148'9		148'9		148'9	
2 boxes / kartons			m3	1,09		1,09		1,09	
2020x530x755	Lacquered Lackiert			AP04860		AP04861		AP04862	
			kg	166'5		166'5		166'5	
4 boxes / kartons			m3	1,25		1,25		1,25	
2520x530x755	Lacquered Lackiert			AP04896		AP04897		AP04898	
			kg	181'7		181'7		181'7	
4 boxes / kartons			m3	1,57		1,57		1,57	
3020x530x755	Lacquered Lackiert			AP04932		AP04933		AP04934	
			kg	208'9		208'9		208'9	
5 boxes / kartons			m3	1,82		1,82		1,82	





Aufpreis für Glanzverchromt
Polished Chrome upcharge

Aufpreis für Glanzverchromt
Polished Chrome upcharge

Aufpreis für Glanzverchromt
Polished Chrome upcharge

Aufpreis für Glanzverchromt
Polished Chrome upcharge

Optional table tops /Sobres opcionales					
Top measures Medidas Sobres	***Technical Stone 8	***Low Iron Glass Optisch Glas	***Marble M1 Marmor M1	Marble M2 Marmor M2	Marble M3 Marmor M3
1520x530x755					
 kg					
 m3					
2020x530x755					
 kg					
 m3					
2520x530x755					
 kg					
 m3					
3020x530x755					
 kg					
 m3					

***Marble shiny
upcharge
Aufpreis für marmor
glänzend

CONFIGURATION DIAGRAM
KONFIGURATIONSDIAGRAMM

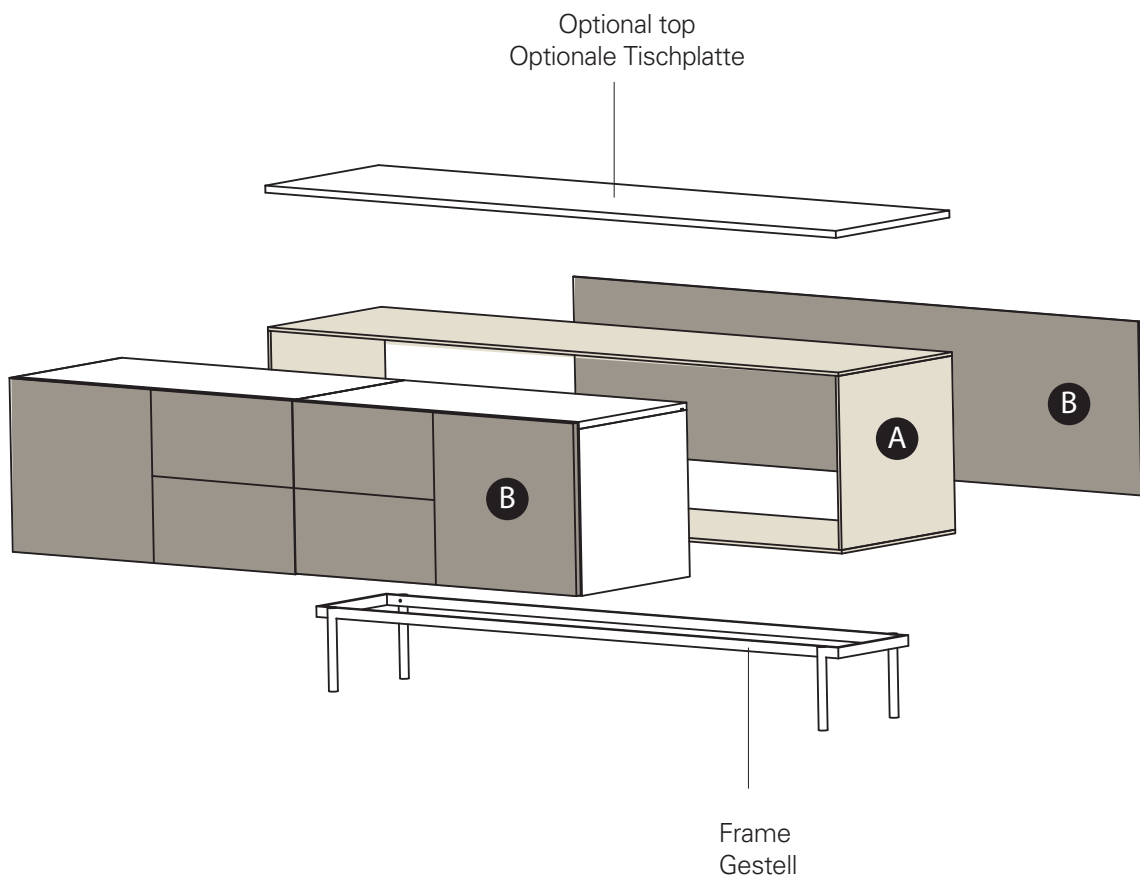

- A** Exterior material / Aussenmaterial
- B** Front and back material / Vorder- und Rückenmaterial

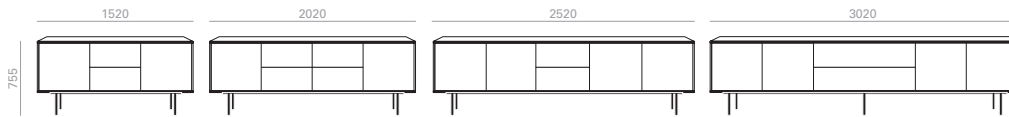

Column height / Höhe der Säule									
Top measures Größe der Tischplatte*	Exterior material Außenmaterial			Table top / Tischplatten					
				Oak Eiche		Walnut Nussbaum		Lacquered Lackiert	
				Ref.		Ref.		Ref.	
1520x530x755	Oak Eiche	S600		AP04827		AP04828		AP04829	
kg				148'9		148'9		148'9	
2 boxes / kartons				1,09		1,09		1,09	
2020x530x755	Oak Eiche	S600		AP04863		AP04864		AP04865	
kg				166'5		166'5		166'5	
4 boxes / kartons				1,25		1,25		1,25	
2520x530x755	Oak Eiche	S600		AP04899		AP04900		AP04901	
kg				181'7		181'7		181'7	
4 boxes / kartons				1,57		1,57		1,57	
3020x530x755	Oak Eiche	S600		AP04935		AP04936		AP04937	
kg				208'9		208'9		208'9	
5 boxes / kartons				1,82		1,82		1,82	
1520x530x755	Walnut Nussbaum			AP04830		AP04831		AP04832	
kg				148'9		148'9		148'9	
2 boxes / kartons				1,09		1,09		1,09	
2020x530x755	Walnut Nussbaum			AP04866		AP04867		AP04868	
kg				166'5		166'5		166'5	
4 boxes / kartons				1,25		1,25		1,25	
2520x530x755	Walnut Nussbaum			AP04902		AP04903		AP04904	
kg				181'7		181'7		181'7	
4 boxes / kartons				1,57		1,57		1,57	
3020x530x755	Walnut Nussbaum			AP04938		AP04939		AP04940	
kg				208'9		208'9		208'9	
5 boxes / kartons				1,82		1,82		1,82	
1520x530x755	Lacquered Lackiert			AP04833		AP04834		AP04835	
kg				148'9		148'9		148'9	
2 boxes / kartons				1,09		1,09		1,09	
2020x530x755	Lacquered Lackiert			AP04869		AP04870		AP04871	
kg				166'5		166'5		166'5	
4 boxes / kartons				1,25		1,25		1,25	
2520x530x755	Lacquered Lackiert			AP04905		AP04906		AP04907	
kg				181'7		181'7		181'7	
4 boxes / kartons				1,57		1,57		1,57	
3020x530x755	Lacquered Lackiert			AP04941		AP04942		AP04943	
kg				208'9		208'9		208'9	
5 boxes / kartons				1,82		1,82		1,82	











Aufpreis für Glanzverchromt
Polished Chrome upcharge

Aufpreis für Glanzverchromt
Polished Chrome upcharge

Aufpreis für Glanzverchromt
Polished Chrome upcharge

Aufpreis für Glanzverchromt
Polished Chrome upcharge

Optional table tops /Sobres opcionales					
Top measures Medidas Sobres	***Technical Stone 8	***Low Iron Glass Optisch Glas	***Marble M1 Marmor M1	Marble M2 Marmor M2	Marble M3 Marmor M3
1520x530x755					
 kg					
 m3					
2020x530x755					
 kg					
 m3					
2520x530x755					
 kg					
 m3					
3020x530x755					
 kg					
 m3					

***Marble shiny
upcharge
Aufpreis für marmor
glänzend