

BAI A DI DI
by Neri&Hu, 2014

Wall lamp. Structure in bronze electroplated steel. Diffuser in blown transparent, amber and grey glass. Strip led column and dimmable driver included.

Type: Wall lamp

Environment: Indoor

Structure: Steel

Diffuser: Glass

Voltage: 230 V

Supply: Terminal strip

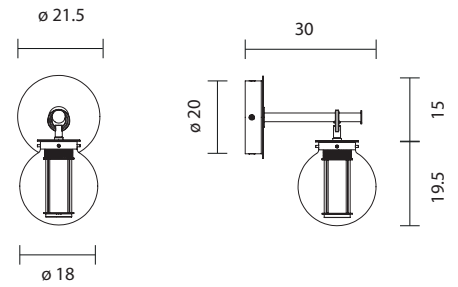

Dimmable driver included

Light source: Strip LED 7.7W 2700K 570Lm



BAI A DI DI

403000640976 **amber diffuser**
403000640977 **grey diffuser**
403000640978 **transparent diffuser**

CE   IP-20

 **2.2 kg**
4.8 kg

BAI A BA BA
by Neri&Hu, 2014

Wall lamp. Structure in bronze electroplated steel. Diffuser in blown transparent, amber and grey glass. Strip led column (dimmable driver included) provide ambient light and module led placed at the bottom (connected direct to main) provide direct light.

Type: Wall lamp

Environment: Indoor

Structure: Steel

Diffuser: Glass

Voltage: 230 V

Supply: Terminal strip

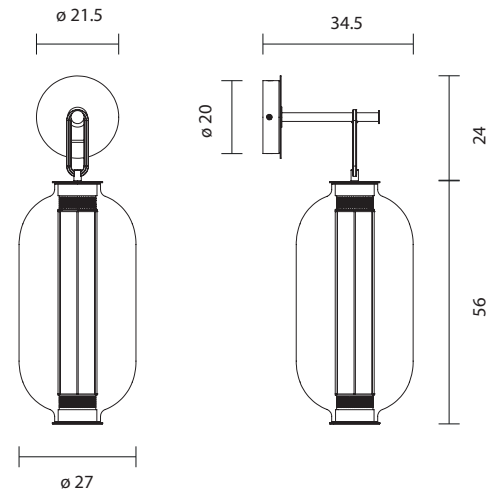

Dimmable driver included

Light source: Strip LED 15.4W 2700K 1150Lm
+ Module LED $\varnothing 70$ 16.6W 2700K 1350Lm



BAI A BA BA

402000640976 **amber diffuser**
402000640977 **grey diffuser**
402000640978 **transparent diffuser**

CE   IP-20

 **8.6 kg**
16.2 kg