



BABEL T PE

by Stephen Burks, 2014

Suspension lamp. Ilimited options can be created by combining the modules in anodized aluminium yellow, orange and red. We offer two light source options: strip led column+module led on the bottom or only strip led column.



Lámpara de suspensión. Formada por módulos de aluminio anodizado amarillo, naranja y rojo, que permiten crear ilimitadas combinaciones. Existen dos opciones de fuente de luz: una compuesta de una columna de strip leds + un módulo led en la parte inferior o solo con columna strip led.

18 x 30 Module Módulo
 808000000025 **orange** / naranja
 808000000011 **red** / rojo
 808000000026 **yellow** / amarillo

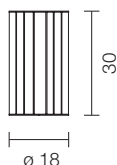
 2.1 kg
 2.6 kg



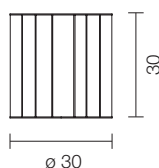

30 x 30 Module Módulo
 809000000025 **orange** / naranja
 809000000011 **red** / rojo
 809000000026 **yellow** / amarillo

 4.1 kg
 5.1 kg



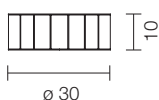

30 x 10 Module Módulo
 810000000025 **orange** / naranja
 810000000011 **red** / rojo
 810000000026 **yellow** / amarillo

 2.6 kg
 3.0 kg



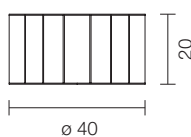

40 x 20 Module Módulo
 811000000025 **orange** / naranja
 811000000011 **red** / rojo
 811000000026 **yellow** / amarillo

 5.2 kg
 6.2 kg



Electric group Grupo eléctrico
 123000600000 **indirect light only** / sólo luz difusa
 123000601000 **indirect light + direct light**

 3.8 kg / luz difusa + luz directa
 5.0 kg

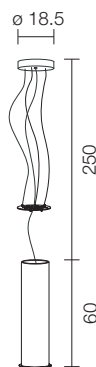

Light Source Fuente de luz
 Strip led: 21 W - 2700 K - 1580 lm (*)
 Strip led: 19.5 W - 2700 K - 1440 lm +
 1 module led: \varnothing 70 - 17 W - 2700 K - 1400 lm (*), (**)

Cable length Longitud de cable: 250 cm

Voltage Voltaje: 240 V



(*) For dimmable options please contact info@parachilna.eu
 (*) Para opciones de dimerización consultar info@parachilna.eu

(**) For 1 or 2 lites possibilities please see installation instructions.
 (**) Para la posibilidad de 1 o 2 encendidos ver manual de instrucciones.

Example Ejemplo

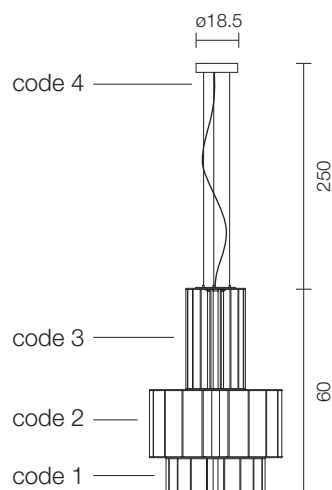
code 1
Structure Estructura módulo
 810000000026
 +
 code 2
Structure Estructura módulo
 811000000025
 +
 code 3
Structure Estructura módulo
 808000000011
 +
 code 4
Electric Group Grupo eléctrico
 123000600000



CE   IP-20

Some possible combinations Algunas combinaciones posibles

