

Story Base



The Story table is available with a fixed or folding top. The 4-star polished aluminum base has adjustable levelers with 1/2" leveling range.

The Story base is available in a table height as well as a bar height. The base is appropriate for round or square tops ranging from 24" to 42" as well as a 30" x 24" rectangular top.

The Story conference table collection is available upon request with certifications for level® 1, GREENGUARD and FSC Chain-of-Custody. Requests must be made in writing in advance of or during the quoting process as upcharges may apply. For complete information regarding the level 1, GREENGUARD and FSC certifications for Story, please contact [bgreen@bernhardt.com](mailto:bgreen@bernhardt.com).

Approved for GSA Contract GS-28F-7040G.



Detail View of Story Leg

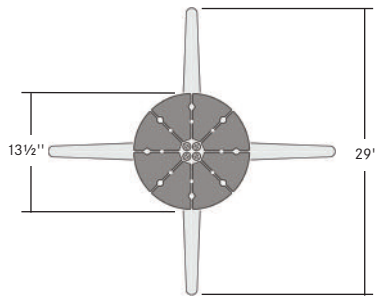

Plan View of Story Base

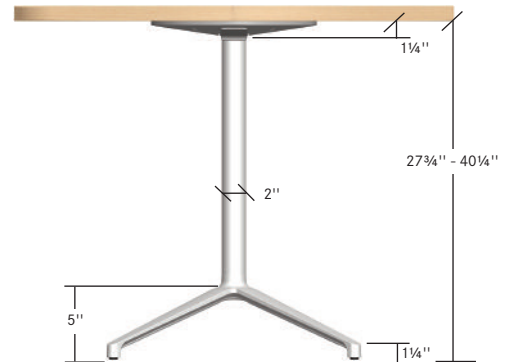

Elevation View of Story Base

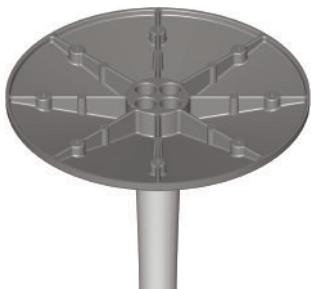

Fixed Base

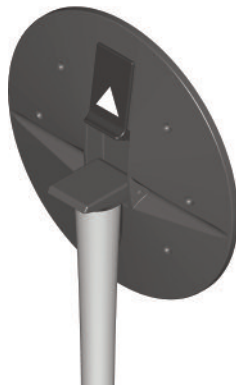

Folding Base with Latch Mechanism







Nested Tables



**story bases**

available in fixed or folding base in two heights  
 standard table height and bar height  
 approved for GSA Contract GS-28F-7040G  
 Level 1 Certified  
 GREENGUARD Certified

description	sku	w	d	h	weight	specifications	price
 <b>table height fixed</b>	5FX	29	29	27¾	35	use with 24-42" w tops	
 <b>table height folding</b>	5FD	29	29	27¾	35	use with 24-42" w tops	
 <b>bar height fixed</b>	6FX	29	29	40¼	40	use with 24-30" w tops	
 <b>bar height folding</b>	6FD	29	29	40¼	40	use with 24-30" w tops	

**specification codes**

**series**

story

v

**sku**

**veneer**

none

x

**style**

none

x

**base**

polished aluminum

6

**finish**

x  x  x

Story Tops



Detail view of the Story top with the folding base.

Story tops are specifically constructed to accommodate the Story table base.

The Story table is available with round or square tops ranging from 24" to 42" and a 30" x 24" rectangular top with a flat or bevel edge.

The Story conference table collection is available upon request with certifications for level® 1, GREENGUARD and FSC Chain-of-Custody. Requests must be made in writing in advance of or during the quoting process as upcharges may apply. For complete information regarding the level 1, GREENGUARD and FSC certifications for Story, please contact [bgreen@bernhardt.com](mailto:bgreen@bernhardt.com).

Veneer Selections

Laminates

- F Plain/Abstract Laminate
- W Woodgrain Laminate

A variety of standard laminate finishes are available with vinyl edge bands specifically formulated to correspond to standard laminates. See finish selections in the appendix for standard laminates and edge bands.

Veneer

- C Oak  
Rift Cut
- E Maple  
Flat Cut
- J Cherry  
Flat Cut
- 9 Walnut  
Flat Cut
- G Paldao  
Quarter Cut

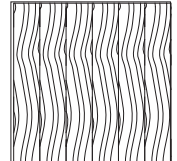
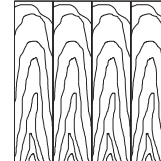
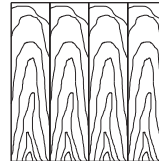
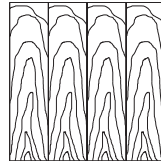
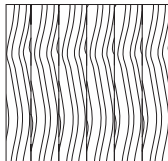

Edge Group A

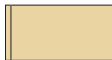





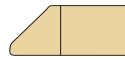

- F Flat - 1 1/4"

Edge Group B

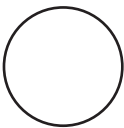

- W Bevel - 1"

specification codes	series	sku	veneer	edge	base	finish
	<span style="border: 1px solid black; padding: 2px;">Q</span> top		<ul style="list-style-type: none"> <li><span style="border: 1px solid black; padding: 0 2px;">F</span> plain/abstract laminate</li> <li><span style="border: 1px solid black; padding: 0 2px;">W</span> woodgrain laminate</li> <li><span style="border: 1px solid black; padding: 0 2px;">J</span> cherry</li> <li><span style="border: 1px solid black; padding: 0 2px;">E</span> maple</li> <li><span style="border: 1px solid black; padding: 0 2px;">C</span> oak</li> <li><span style="border: 1px solid black; padding: 0 2px;">9</span> walnut</li> <li><span style="border: 1px solid black; padding: 0 2px;">G</span> paldao</li> </ul>	<p><b>laminate</b></p> <ul style="list-style-type: none"> <li><span style="border: 1px solid black; padding: 0 2px;">F</span> 1 1/4" flat</li> </ul> <p><b>group A</b></p> <ul style="list-style-type: none"> <li><span style="border: 1px solid black; padding: 0 2px;">F</span> 1 1/4" flat</li> </ul> <p><b>group B</b></p> <ul style="list-style-type: none"> <li><span style="border: 1px solid black; padding: 0 2px;">W</span> 1" bevel</li> </ul>	<ul style="list-style-type: none"> <li><span style="border: 1px solid black; padding: 0 2px;">V</span> story base</li> </ul>	see appendix
	<span style="border: 1px solid black; padding: 2px;">Q</span>	_ _ _	_	_	<span style="border: 1px solid black; padding: 2px;">V</span>	_ _ _

	<p><b>story tops</b></p> <p>tops sold separately order bases separately approved for GSA Contract GS-28F-7040G Level 1 Certified GREENGUARD Certified</p>			laminata		cherry maple oak walnut	paldao			
										
	sku	w	d	specifications	plain abstract	woodgrain	edge group A	edge group B	edge group A	edge group B
<b>round top</b>	YAY	24	24							
	YAL	27	27							
	YAX	30	30							
	YAW	36	36	use with table height base only						
	YAV	42	42	use with table height base only						
<b>square top</b>	YBY	24	24							
	YBL	27	27							
	YBX	30	30							
	YBW	36	36	use with table height base only						
	<b>rectangular top</b>	YCD	30	24						
										

<b>specification codes</b>	<b>series</b>	<b>sku</b>	<b>veneer</b>	<b>edge</b>	<b>base</b>	<b>finish</b>
Q   top			F   plain/abstract laminate W   woodgrain laminate J   cherry E   maple C   oak 9   walnut G   paldao	<b>laminata</b> F   1/4" flat <b>group A</b> F   1/4" flat <b>group B</b> W   1" bevel	V   story base	see appendix
Q					V	